

UNIT	COOLING TOWER	
MODEL #	AT 217-4J9	SCALE NTS

EVAPCO, INC.

DWG. #	T3170948-DRG-ST	REV.	-
SERIAL #		DATE	7/10/2026

NOTES:

- (M)- FAN MOTOR LOCATION
- HEAVIEST SECTION IS UPPER SECTION
- MPT DENOTES MALE PIPE THREAD
FPT DENOTES FEMALE PIPE THREAD
BFW DENOTES BEVELED FOR WELDING
GVD DENOTES GROOVED
FLG DENOTES FLANGE
- +UNIT WEIGHT DOES NOT INCLUDE ACCESSORIES (SEE ACCESSORY DRAWINGS)
- MAKE-UP WATER PRESSURE
20 psi MIN [137 kPa], 50 psi MAX [344 kPa]
- 3/4" [19MM] DIA. MOUNTING HOLES.
REFER TO RECOMMENDED STEEL SUPPORT DRAWING
- DIMENSIONS LISTED AS FOLLOWS:
ENGLISH FT-IN
[METRIC] [mm]

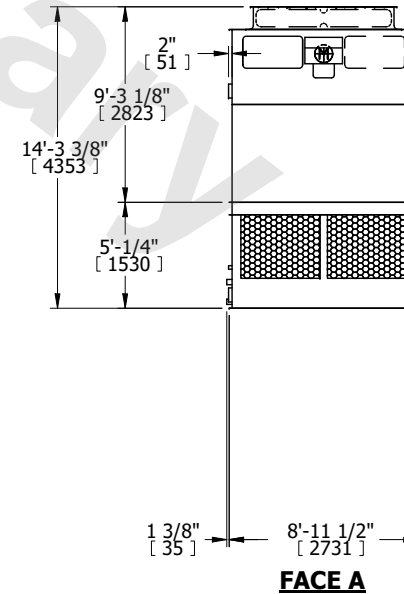
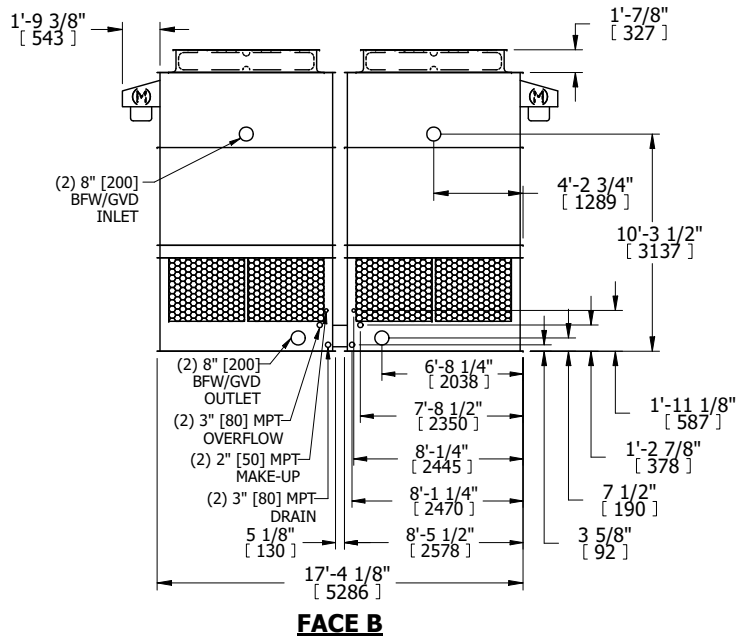
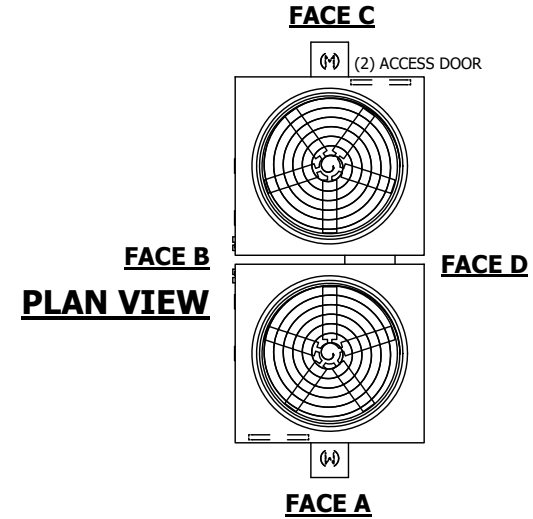

SHIPPING WEIGHT	9860 lbs+ [4475] kg+	OPERATING WEIGHT	15540 lbs+ [7050] kg+	HEAVIEST SECTION WEIGHT	3390 lbs+ [1540] kg+	NO. OF SHIPPING SECTIONS	2	DRAWN BY:	KDS
-----------------	----------------------	------------------	-----------------------	-------------------------	----------------------	--------------------------	---	-----------	-----