

UNIT	COOLING TOWER	
MODEL #	AT 428-5M52	SCALE NTS

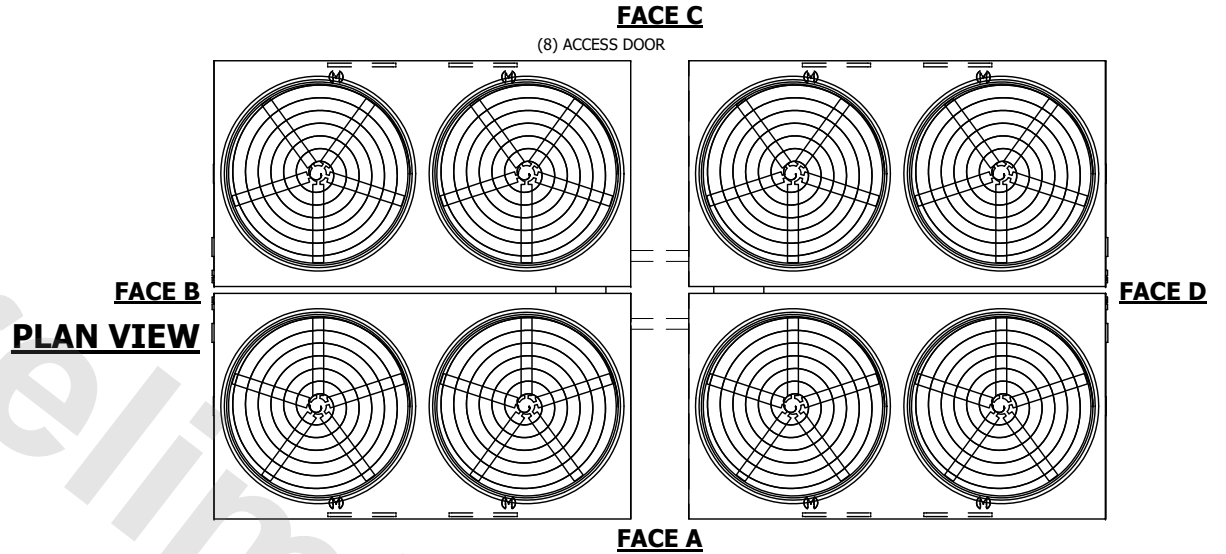

DWG. #	T4285260-DRA-ST	REV.	-
SERIAL #		DATE	6/24/2026

- NOTES:
- (M)- FAN MOTOR LOCATION
 - HEAVIEST SECTION IS UPPER SECTION
 - MPT DENOTES MALE PIPE THREAD
FPT DENOTES FEMALE PIPE THREAD
BFW DENOTES BEVELED FOR WELDING
GVD DENOTES GROOVED
FLG DENOTES FLANGE
PE DENOTES PLAIN END
 - +UNIT WEIGHT DOES NOT INCLUDE ACCESSORIES (SEE ACCESSORY DRAWINGS)
 - MAKE-UP WATER PRESSURE
20 psi MIN [137 kPa], 50 psi MAX [344 kPa]
 - 3/4" [19MM] DIA. MOUNTING HOLES.
REFER TO RECOMMENDED STEEL SUPPORT DRAWING
 - DIMENSIONS LISTED AS FOLLOWS:
ENGLISH FT-IN
[METRIC] [mm]
 - PAN FLUME BOX EQUALIZERS SUPPLIED BY EVAPCO. PAN EQUALIZER PIPING IS SUPPLIED BY OTHERS.
 - PAN EQUALIZER NIPPLE IS 11'-10 3/8" [3616]
OFF EACH STEP SIDE.



SHIPPING WEIGHT	97840 lbs+ [44380] kg+	OPERATING WEIGHT	164400 lbs+ [74575] kg+	HEAVIEST SECTION WEIGHT	17820 lbs+ [8085] kg+	NO. OF SHIPPING SECTIONS	8	DRAWN BY:	MER
-----------------	------------------------	------------------	-------------------------	-------------------------	-----------------------	--------------------------	---	-----------	-----