

|         |                  |           |
|---------|------------------|-----------|
| UNIT    | <b>CONDENSER</b> |           |
| MODEL # | eco-ATC-751A     | SCALE NTS |

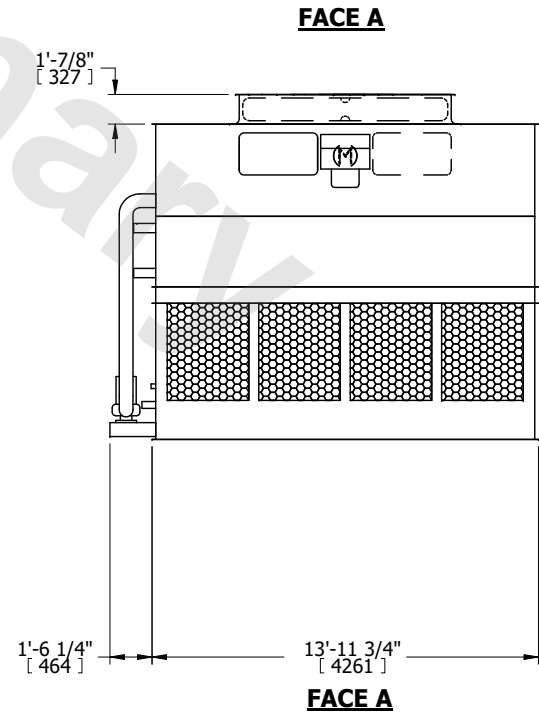

|          |                 |      |           |
|----------|-----------------|------|-----------|
| DWG. #   | EG171406-DRC-ST | REV. | -         |
| SERIAL # |                 | DATE | 6/20/2026 |

- NOTES:
- (M)- FAN MOTOR LOCATION
  - HEAVIEST SECTION IS UPPER SECTION
  - MPT DENOTES MALE PIPE THREAD  
FPT DENOTES FEMALE PIPE THREAD  
BFW DENOTES BEVELED FOR WELDING  
GVD DENOTES GROOVED  
FLG DENOTES FLANGE  
PE DENOTES PLAIN END
  - +UNIT WEIGHT DOES NOT INCLUDE ACCESSORIES (SEE ACCESSORY DRAWINGS)
  - MAKE-UP WATER PRESSURE  
20 psi MIN [137 kPa], 50 psi MAX [344 kPa]
  - \*-APPROXIMATE DIMENSIONS DO NOT USE FOR PRE-FABRICATION OF CONNECTING PIPING
  - 3/4" [19MM] DIA. MOUNTING HOLES. REFER TO RECOMMENDED STEEL SUPPORT DRAWING.
  - DIMENSIONS LISTED AS FOLLOWS:  
ENGLISH FT-IN  
METRIC [mm]

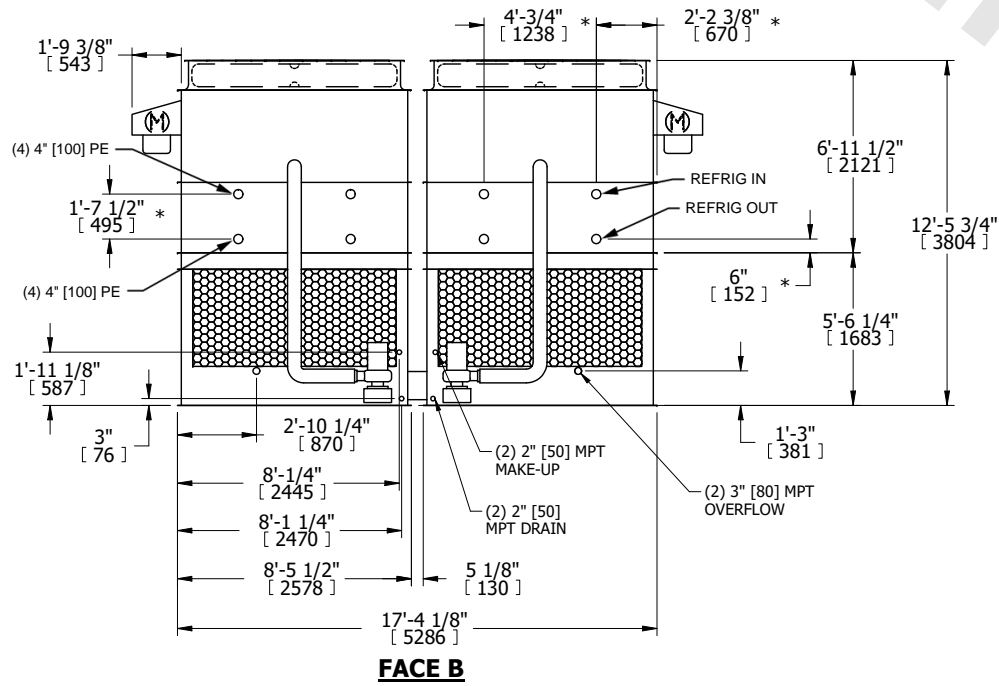
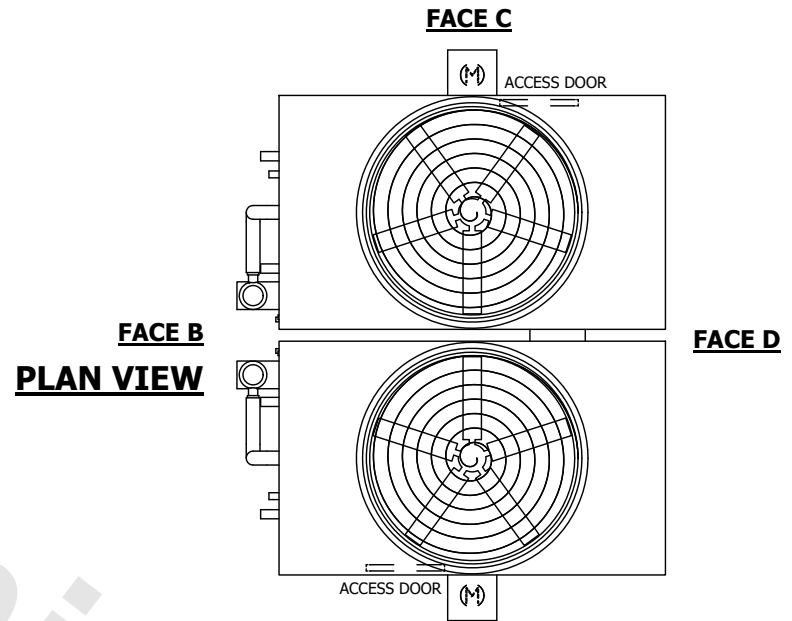

|                 |                        |                  |                        |                         |                       |                          |   |           |     |
|-----------------|------------------------|------------------|------------------------|-------------------------|-----------------------|--------------------------|---|-----------|-----|
| SHIPPING WEIGHT | 27380 lbs+ [12420] kg+ | OPERATING WEIGHT | 36780 lbs+ [16685] kg+ | HEAVIEST SECTION WEIGHT | 11610 lbs+ [5270] kg+ | NO. OF SHIPPING SECTIONS | 4 | DRAWN BY: | TLM |
|-----------------|------------------------|------------------|------------------------|-------------------------|-----------------------|--------------------------|---|-----------|-----|