

UNIT	CONDENSER	
MODEL #	ATC-1026E	SCALE NTS

EVAPCO, INC.

DWG. #	C4122410-DRA-ST	REV	-
SERIAL #		DATE:	5/15/2026

NOTES

- (M)- FAN MOTOR LOCATION
- MPT DENOTES MALE PIPE THREAD
FPT DENOTES FEMALE PIPE THREAD
BFW DENOTES BEVELED FOR WELDING
GVD DENOTES GROOVED
FLG DENOTES FLANGE
PE DENOTES PLAIN END
- +UNIT WEIGHT DOES NOT INCLUDE ACCESSORIES (SEE ACCESSORY DRAWINGS)
- MAKE-UP WATER PRESSURE
20 psi MIN [137 kPa], 50 psi MAX [344 kPa]
- *-APPROXIMATE DIMENSIONS DO NOT USE FOR PRE-FABRICATION OF CONNECTING PIPING
- 3/4" [19mm] DIA. MOUNTING HOLES. REFER TO RECOMMENDED STEEL SUPPORT DRAWING.
- DIMENSIONS LISTED AS FOLLOWS:
ENGLISH FT-IN
METRIC [mm]

**FACE B
PLAN VIEW**

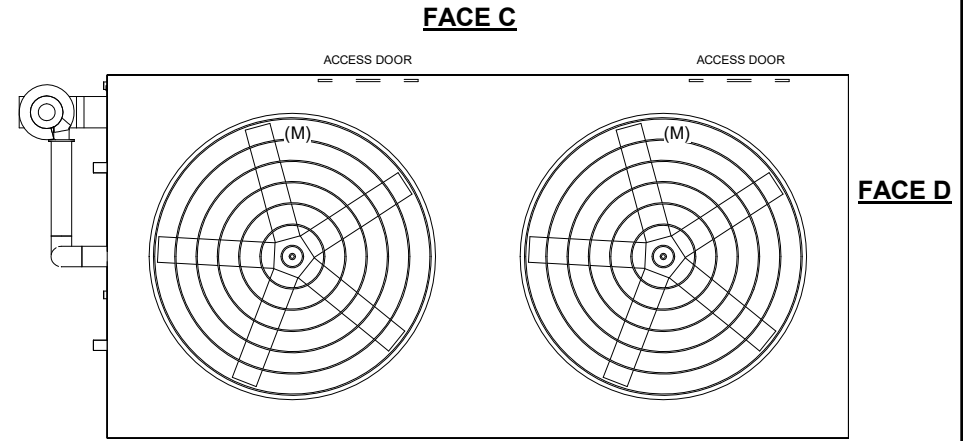

FACE A

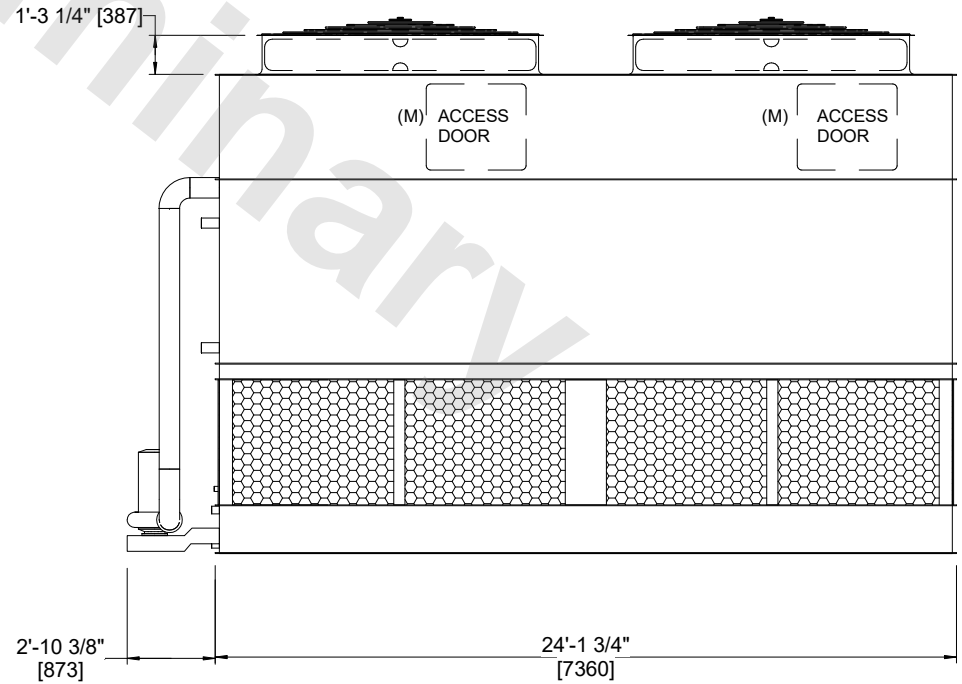
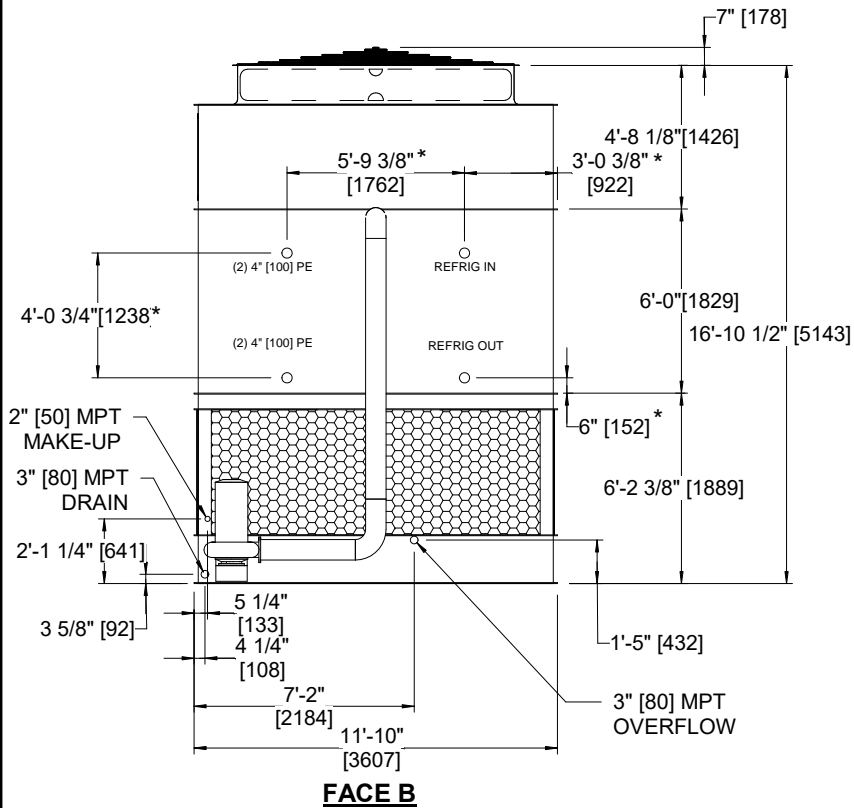

FACE A

SHIPPING WEIGHT	38540 lbs+ [17485] kg+	OPERATING WEIGHT	51580 lbs+ [23400] kg+	HEAVIEST SECTION WEIGHT	31920 lbs+ [14480] kg+	NO. OF SHIPPING SECTIONS	2	DRAWN BY:	JLG
-----------------	------------------------	------------------	------------------------	-------------------------	------------------------	--------------------------	---	-----------	-----