

UNIT	COOLING TOWER	
MODEL #	AT 428-2L36	SCALE NTS

# EVAPCO, INC.

DWG. #	T4283624-DRA-ST	REV	-
SERIAL #		DATE:	6/25/2026

**NOTES:**

- (M)- FAN MOTOR LOCATION
- HEAVIEST SECTION IS FAN/CASING SECTION
- MPT DENOTES MALE PIPE THREAD  
FPT DENOTES FEMALE PIPE THREAD  
BFW DENOTES BEVELED FOR WELDING  
GVD DENOTES GROOVED  
FLG DENOTES FLANGE
- +UNIT WEIGHT DOES NOT INCLUDE ACCESSORIES (SEE ACCESSORY DRAWINGS)
- 3/4" [19MM] DIA. MOUNTING HOLES. REFER TO RECOMMENDED STEEL SUPPORT DRAWING
- DIMENSIONS LISTED AS FOLLOWS:  
ENGLISH FT-IN  
[METRIC] [mm]
- MAKE-UP WATER PRESSURE  
20 psi MIN [137 kPa], 50 psi MAX [344 kPa]
- PAN FLUME BOX EQUALIZERS SUPPLIED BY EVAPCO PAN EQUALIZER PIPING IS SUPPLIED BY OTHERS.
- PAN EQUALIZER NIPPLE IS 11'-10 3/8" [3616] OFF EACH STEP SIDE.

**FACE C**



**FACE B  
PLAN VIEW**

**FACE D**

**FACE A**

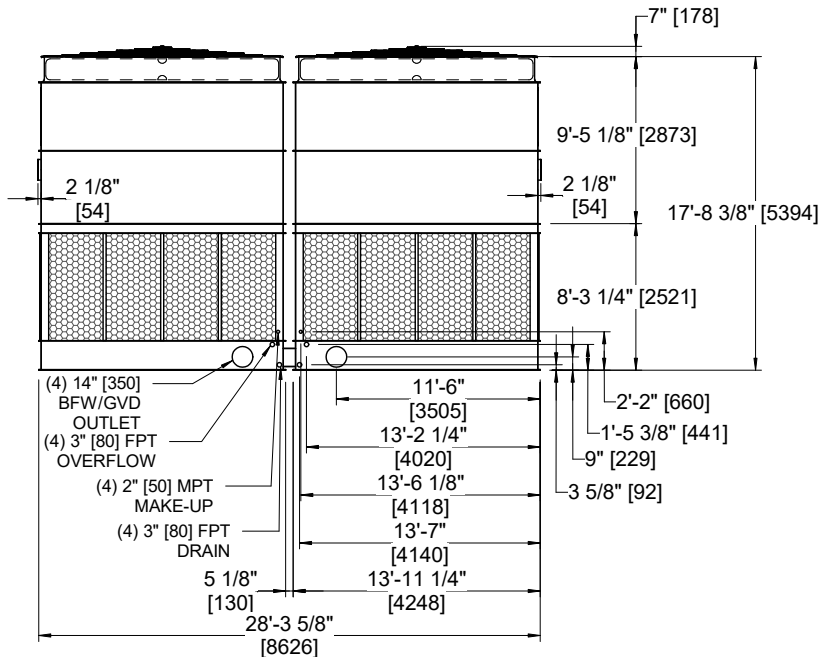

**FACE B**

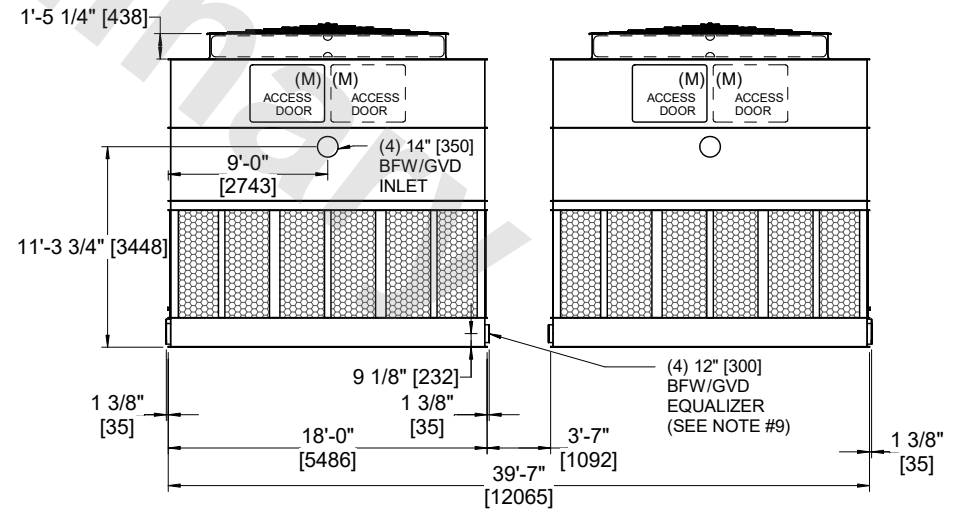

**FACE A**

SHIPPING WEIGHT	62040 lbs+ [28145] kg+	OPERATING WEIGHT	100880 lbs+ [45760] kg+	HEAVIEST SECTION WEIGHT	10420 lbs+ [4730] kg+	NO. OF SHIPPING SECTIONS	8	DRAWN BY:	TRS
-----------------	------------------------	------------------	-------------------------	-------------------------	-----------------------	--------------------------	---	-----------	-----