

UNIT	COOLING TOWER	
MODEL #	AT 428-2036	SCALE NTS

EVAPCO, INC.

DWG. #	T4283624-DRA-ST	REV	-
SERIAL #		DATE:	4/21/2026

NOTES:

- (M)- FAN MOTOR LOCATION
- HEAVIEST SECTION IS FAN/CASING SECTION
- MPT DENOTES MALE PIPE THREAD
FPT DENOTES FEMALE PIPE THREAD
BFW DENOTES BEVELED FOR WELDING
GVD DENOTES GROOVED
FLG DENOTES FLANGE
- +UNIT WEIGHT DOES NOT INCLUDE ACCESSORIES (SEE ACCESSORY DRAWINGS)
- 3/4" [19MM] DIA. MOUNTING HOLES. REFER TO RECOMMENDED STEEL SUPPORT DRAWING
- DIMENSIONS LISTED AS FOLLOWS:
ENGLISH FT-IN
[METRIC] [mm]
- MAKE-UP WATER PRESSURE
20 psi MIN [137 kPa], 50 psi MAX [344 kPa]
- PAN FLUME BOX EQUALIZERS SUPPLIED BY EVAPCO PAN EQUALIZER PIPING IS SUPPLIED BY OTHERS.
- PAN EQUALIZER NIPPLE IS 11'-10 3/8" [3616] OFF EACH STEP SIDE.

**FACE B
PLAN VIEW**

FACE C

FACE D

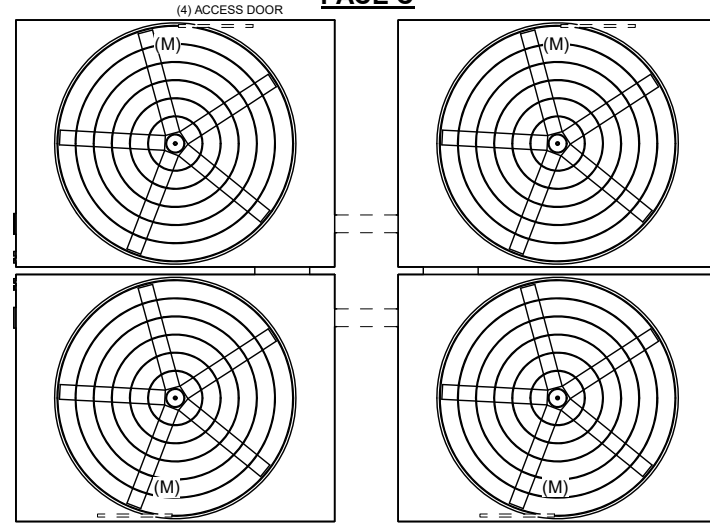

FACE A

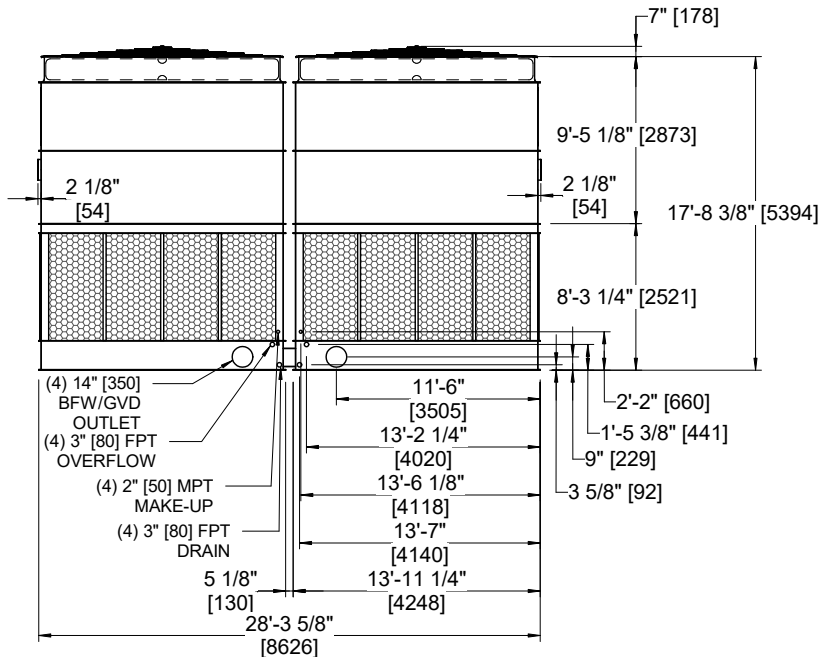

FACE B

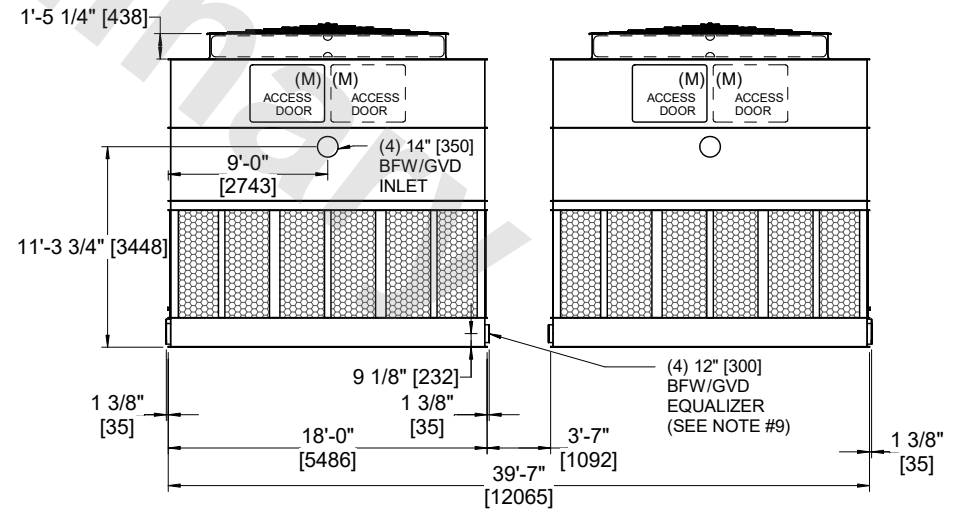

FACE A

SHIPPING WEIGHT	64120 lbs+ [29085] kg+	OPERATING WEIGHT	102960 lbs+ [46705] kg+	HEAVIEST SECTION WEIGHT	10940 lbs+ [4965] kg+	NO. OF SHIPPING SECTIONS	8	DRAWN BY:	TRS
-----------------	------------------------	------------------	-------------------------	-------------------------	-----------------------	--------------------------	---	-----------	-----