

UNIT	COOLING TOWER	
MODEL #	AT 428-4M36	SCALE NTS

EVAPCO, INC.

DWG. #	T4283648-DRA-ST	REV	-
SERIAL #		DATE:	6/24/2026

NOTES:

- (M)- FAN MOTOR LOCATION
- HEAVIEST SECTION IS FAN/CASING SECTION
- MPT DENOTES MALE PIPE THREAD
FPT DENOTES FEMALE PIPE THREAD
BFW DENOTES BEVELED FOR WELDING
GVD DENOTES GROOVED
FLG DENOTES FLANGE
- +UNIT WEIGHT DOES NOT INCLUDE ACCESSORIES (SEE ACCESSORY DRAWINGS)
- 3/4" [19MM] DIA. MOUNTING HOLES. REFER TO RECOMMENDED STEEL SUPPORT DRAWING
- DIMENSIONS LISTED AS FOLLOWS:
ENGLISH FT-IN
[METRIC] [mm]
- MAKE-UP WATER PRESSURE
20 psi MIN [137 kPa], 50 psi MAX [344 kPa]
- PAN FLUME BOX EQUALIZERS SUPPLIED BY EVAPCO PAN EQUALIZER PIPING IS SUPPLIED BY OTHERS.
- PAN EQUALIZER NIPPLE IS 11'-10 3/8" [3616] OFF EACH STEP SIDE.

FACE C



**FACE B
PLAN VIEW**

FACE D



FACE B

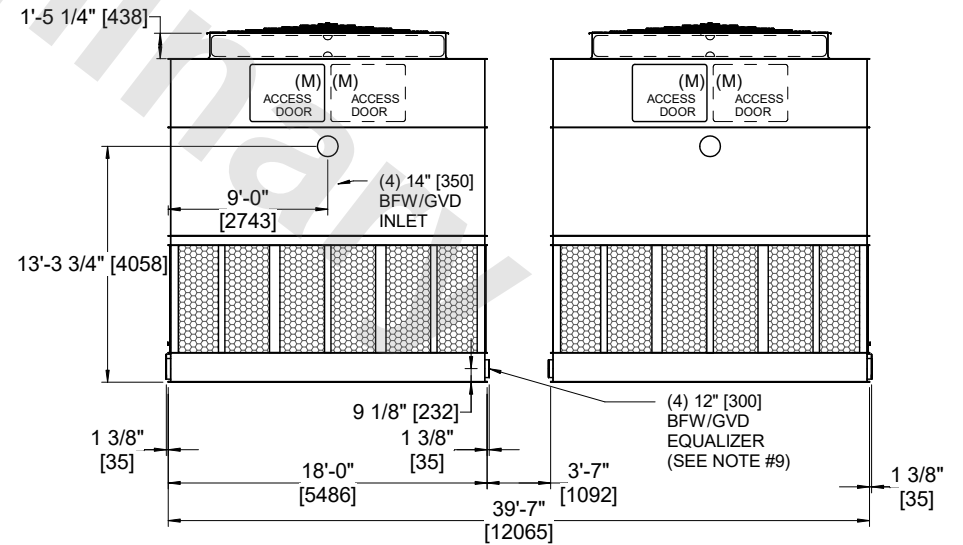

FACE A

SHIPPING WEIGHT 69240 lbs+ [31410] kg+

OPERATING WEIGHT 108080 lbs+ [49025] kg+

HEAVIEST SECTION WEIGHT 12220 lbs+ [5545] kg+

NO. OF SHIPPING SECTIONS 8

DRAWN BY: TRS