

|         |                |           |
|---------|----------------|-----------|
| UNIT    | COOLING TOWER  |           |
| MODEL # | AT 124-5R30-EV | SCALE NTS |

# EVAPCO, INC.

|          |                       |       |           |
|----------|-----------------------|-------|-----------|
| DWG. #   | ATL4BI24304E5T-DRD-DS | REV   | -         |
| SERIAL # |                       | DATE: | 5/24/2026 |

- NOTES**
- (M)- FAN MOTOR LOCATION
  - HEAVIEST SECTION IS CASING SECTION
  - MPT DENOTES MALE PIPE THREAD  
FPT DENOTES FEMALE PIPE THREAD  
BFW DENOTES BEVELED FOR WELDING  
GVD DENOTES GROOVED  
FLG DENOTES FLANGE
  - +UNIT WEIGHT DOES NOT INCLUDE ACCESSORIES (SEE ACCESSORY DRAWINGS)
  - 3/4" [19mm] DIA. MOUNTING HOLES. REFER TO RECOMMENDED STEEL SUPPORT DRAWING
  - DIMENSIONS LISTED AS FOLLOWS  
ENGLISH FT-IN  
[METRIC] [mm]
  - FOR BOTTOM INLET SPECIFICATIONS, SEE DETAIL.

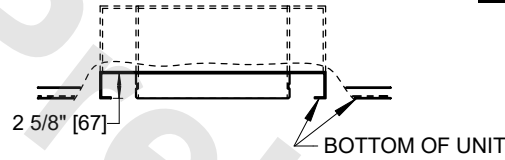

**TYPICAL BOTTOM INLET CONNECTION DETAIL**

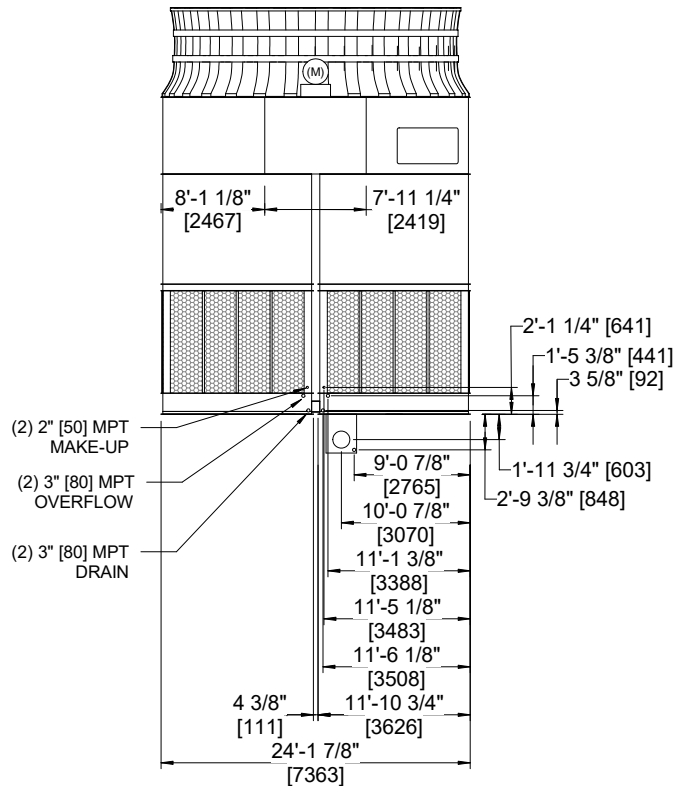
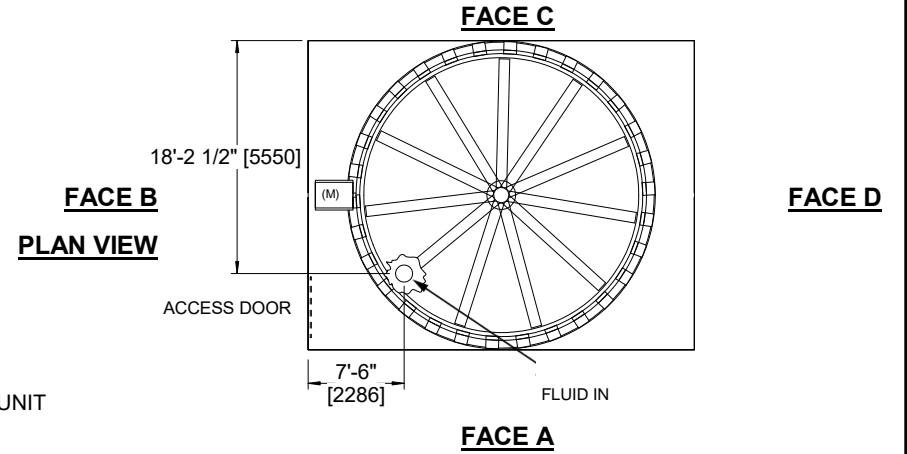

**FACE B**

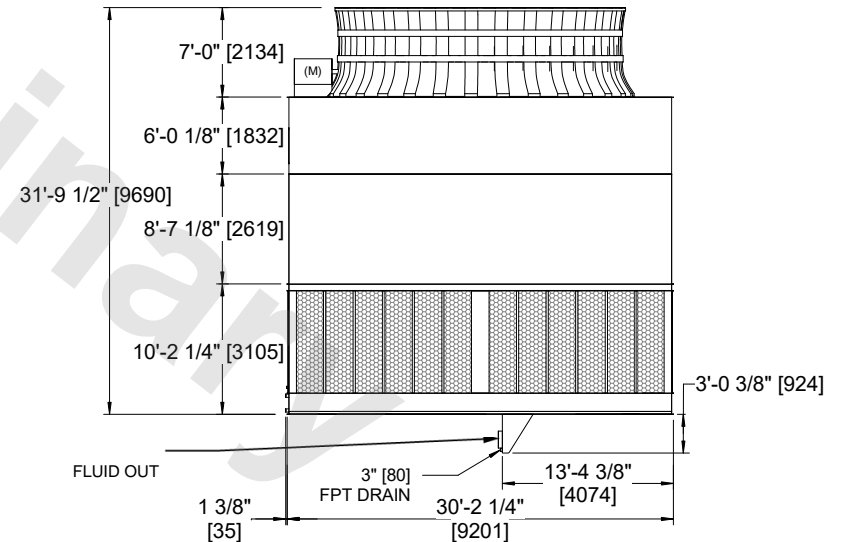

**FACE A**

|                 |                        |                  |                        |                         |                       |                          |   |           |     |
|-----------------|------------------------|------------------|------------------------|-------------------------|-----------------------|--------------------------|---|-----------|-----|
| SHIPPING WEIGHT | 69860 lbs+ [31690] kg+ | OPERATING WEIGHT | 96390 lbs+ [43725] kg+ | HEAVIEST SECTION WEIGHT | 13200 lbs+ [5990] kg+ | NO. OF SHIPPING SECTIONS | 7 | DRAWN BY: | JLG |
|-----------------|------------------------|------------------|------------------------|-------------------------|-----------------------|--------------------------|---|-----------|-----|