

UNIT	COOLING TOWER	
MODEL #	AT 248-5O30-EV	SCALE NTS

# EVAPCO, INC.

DWG. #	ATL4BI48304E5T-DRD-DS	REV	-
SERIAL #		DATE:	7/8/2026

- NOTES**
- (M)- FAN MOTOR LOCATION
  - HEAVIEST SECTION IS CASING SECTION
  - MPT DENOTES MALE PIPE THREAD  
FPT DENOTES FEMALE PIPE THREAD  
BFW DENOTES BEVELED FOR WELDING  
GVD DENOTES GROOVED  
FLG DENOTES FLANGE
  - +UNIT WEIGHT DOES NOT INCLUDE ACCESSORIES (SEE ACCESSORY DRAWINGS)
  - 3/4" [19mm] DIA. MOUNTING HOLES. REFER TO RECOMMENDED STEEL SUPPORT DRAWING
  - DIMENSIONS LISTED AS FOLLOWS  
ENGLISH FT-IN  
[METRIC] [mm]
  - FOR BOTTOM INLET SPECIFICATIONS, SEE DETAIL.



**TYPICAL BOTTOM INLET CONNECTION DETAIL**



**FACE B**

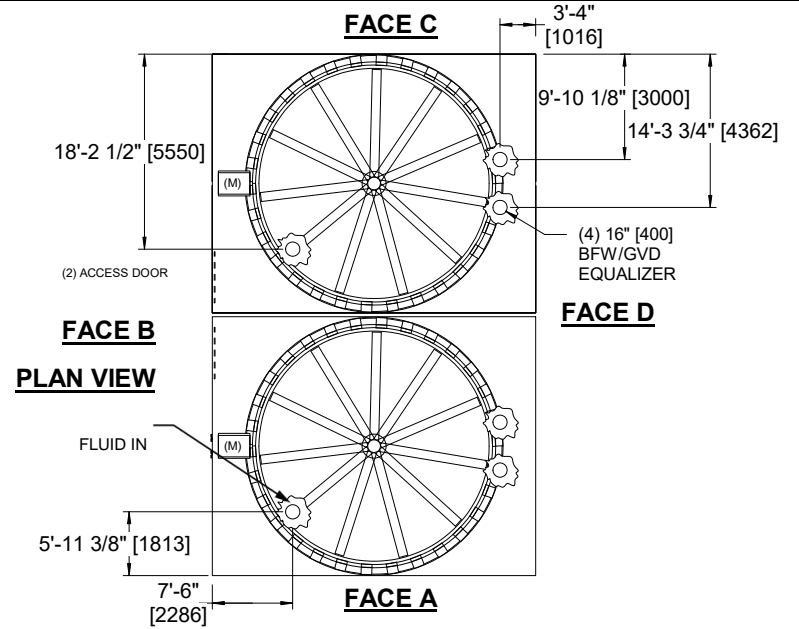

**FACE B PLAN VIEW**

**FACE A**



**FACE A**

SHIPPING WEIGHT	138700 lbs+ [62915] kg+	OPERATING WEIGHT	191760 lbs+ [86985] kg+	HEAVIEST SECTION WEIGHT	13200 lbs+ [5990] kg+	NO. OF SHIPPING SECTIONS	14	DRAWN BY:	JLG
-----------------	-------------------------	------------------	-------------------------	-------------------------	-----------------------	--------------------------	----	-----------	-----