

CONFIDENTIAL

This document is the property of Evapco, Inc. It should not be copied or disclosed without prior written authorization.

CUSTOMER	MODEL # U-SSTWE2-19R44F0075F3KA	SCALE N.T.S.	DWG. # USSTW2-SE-4L	REV. 0	DATE 5/16/2026
----------	---------------------------------	--------------	---------------------	--------	----------------



AIR FLOW DIAGRAM



NOTES:

- 1) * = HANGER HOLE LOCATION.
- 2) HANGER HOLES ARE FOR 3/4 INCH THREADED ROD.
- 3) ALL DIMENSIONS ARE FOR REFERENCE AND SHOULD NOT BE USED FOR PREFABRICATION OF PIPING OR SUPPORTS.

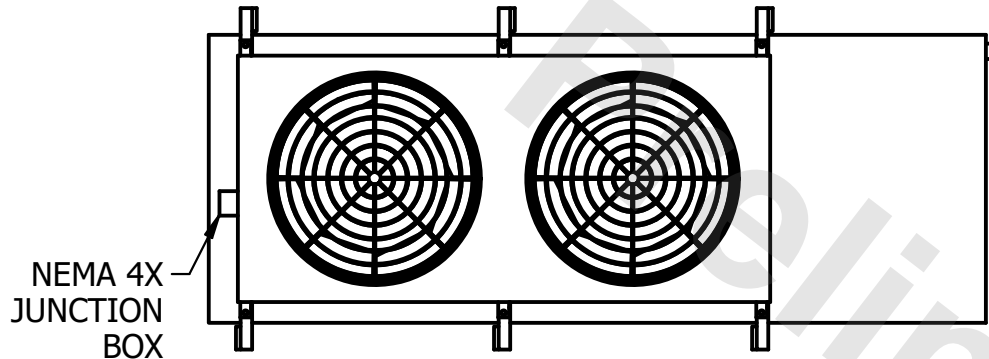

NEMA 4X
JUNCTION
BOX

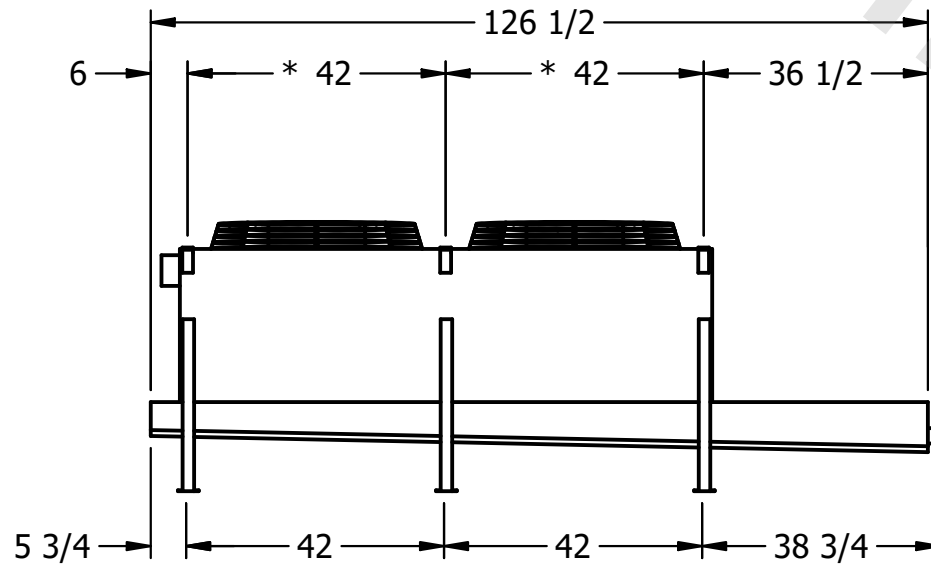

2" MPT
DRAIN

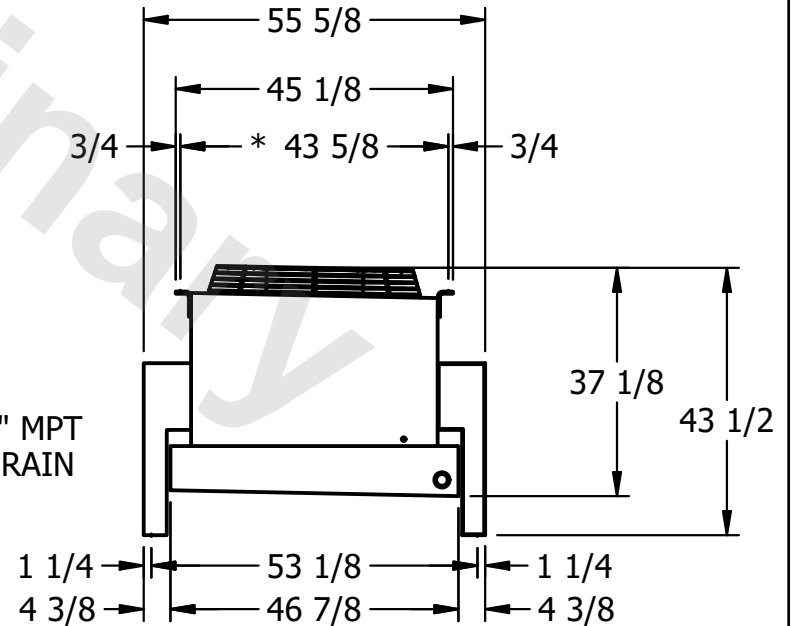

PROJECT	ROOM	SHIPPING WEIGHT 900 lbs+ [410] kg+	OPERATING WEIGHT 990 lbs+ [450] kg+
---------	------	------------------------------------	-------------------------------------