

**CONFIDENTIAL**

This document is the property of Evapco, Inc. It should not be copied or disclosed without prior written authorization.

CUSTOMER	MODEL #	U-SSTWE1-9R43F0075F3KA	SCALE	N.T.S.	DWG. #	USSTW1-SE-4L	REV.	0	DATE	4/24/2026
----------	---------	------------------------	-------	--------	--------	--------------	------	---	------	-----------

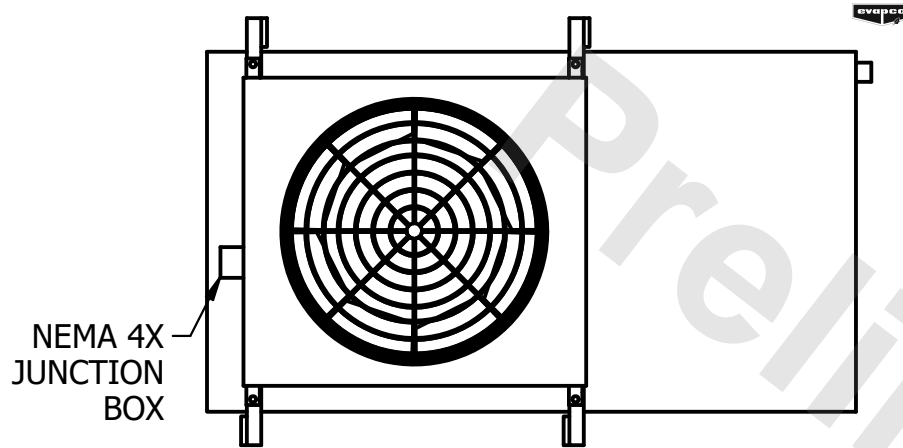

- NOTES:**
- 1) \* = HANGER HOLE LOCATION.
  - 2) HANGER HOLES ARE FOR 3/4 INCH THREADED ROD.
  - 3) ALL DIMENSIONS ARE FOR REFERENCE AND SHOULD NOT BE USED FOR PREFABRICATION OF PIPING OR SUPPORTS.

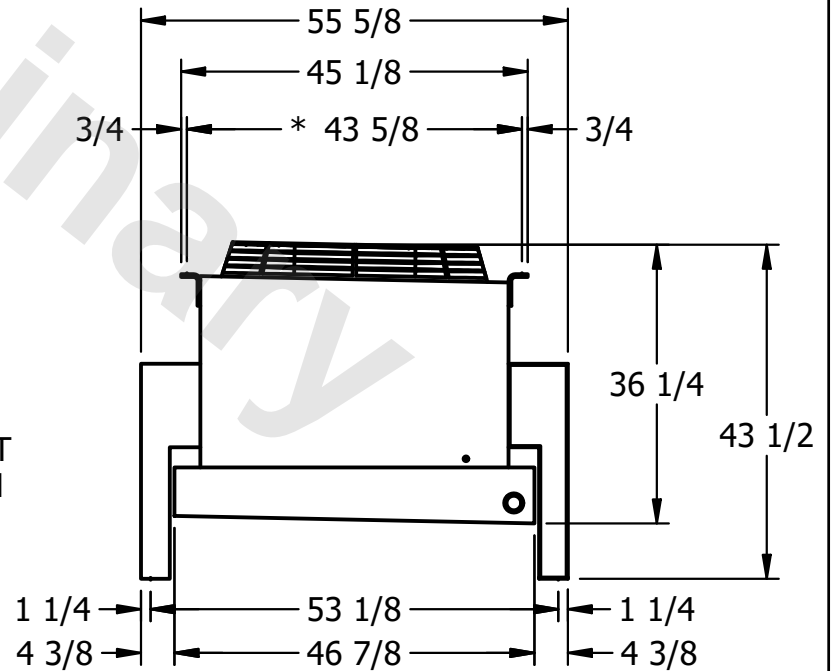

PROJECT	ROOM	SHIPPING WEIGHT	510 lbs+ [235] kg+	OPERATING WEIGHT	540 lbs+ [245] kg+
---------	------	-----------------	--------------------	------------------	--------------------