

CONFIDENTIAL

This document is the property of Evapco, Inc. It should not be copied or disclosed without prior written authorization.

CUSTOMER	MODEL #	U-SSTWE1-9S44F0075F3LA	SCALE	N.T.S.	DWG. #	USSTW1-SE-8	REV.	0	DATE	5/15/2026
----------	---------	------------------------	-------	--------	--------	-------------	------	---	------	-----------



NOTES:

- 1) * = HANGER HOLE LOCATION.
- 2) HANGER HOLES ARE FOR 3/4 INCH THREADED ROD.
- 3) ALL DIMENSIONS ARE FOR REFERENCE AND SHOULD NOT BE USED FOR PREFABRICATION OF PIPING OR SUPPORTS.

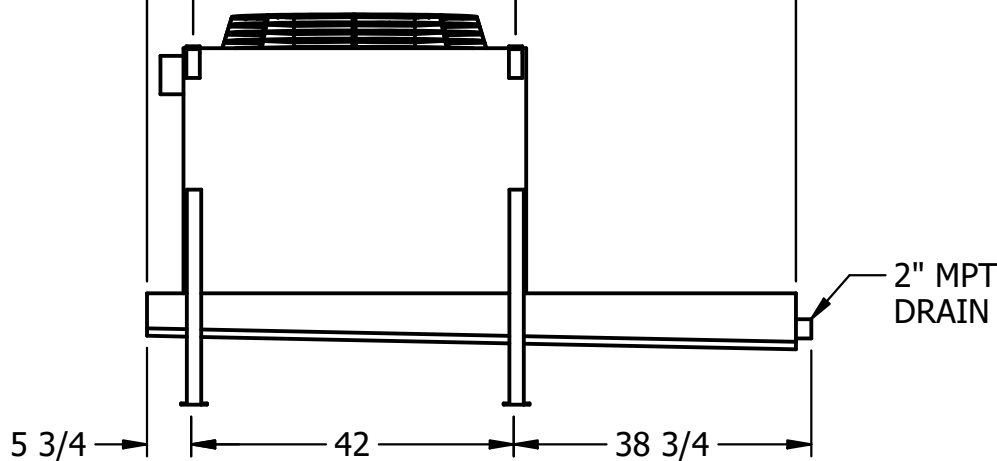
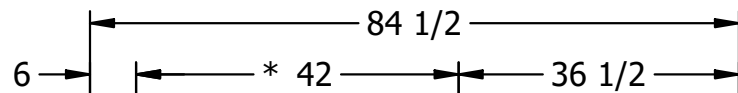

PROJECT	ROOM	SHIPPING WEIGHT	480 lbs+ [220] kg+	OPERATING WEIGHT	530 lbs+ [245] kg+
---------	------	-----------------	--------------------	------------------	--------------------