

CONFIDENTIAL

This document is the property of Evapco, Inc. It should not be copied or disclosed without prior written authorization.

CUSTOMER	MODEL # U-SSTWE2-19S64F0075F1LA	SCALE N.T.S.	DWG. # USSTW2-SE-8	REV. 0	DATE 7/8/2025
----------	---------------------------------	--------------	--------------------	--------	---------------

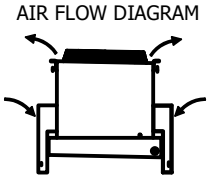
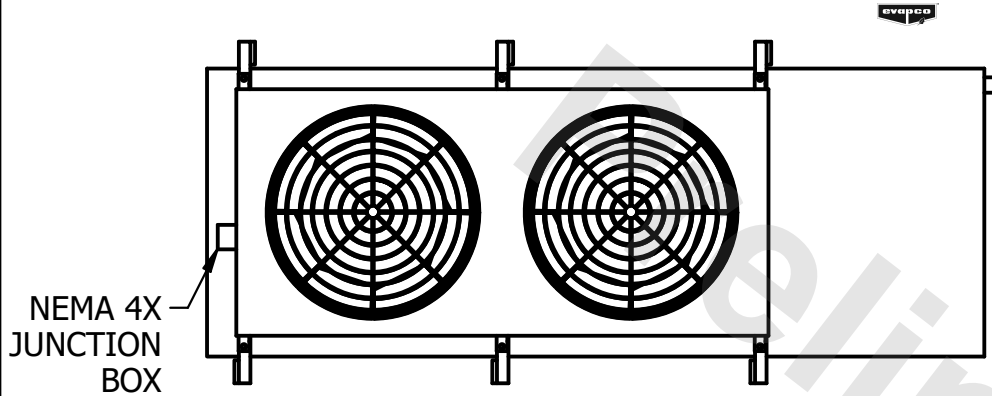

- NOTES:**
- 1) * = HANGER HOLE LOCATION.
 - 2) HANGER HOLES ARE FOR 3/4 INCH THREADED ROD.
 - 3) ALL DIMENSIONS ARE FOR REFERENCE AND SHOULD NOT BE USED FOR PREFABRICATION OF PIPING OR SUPPORTS.

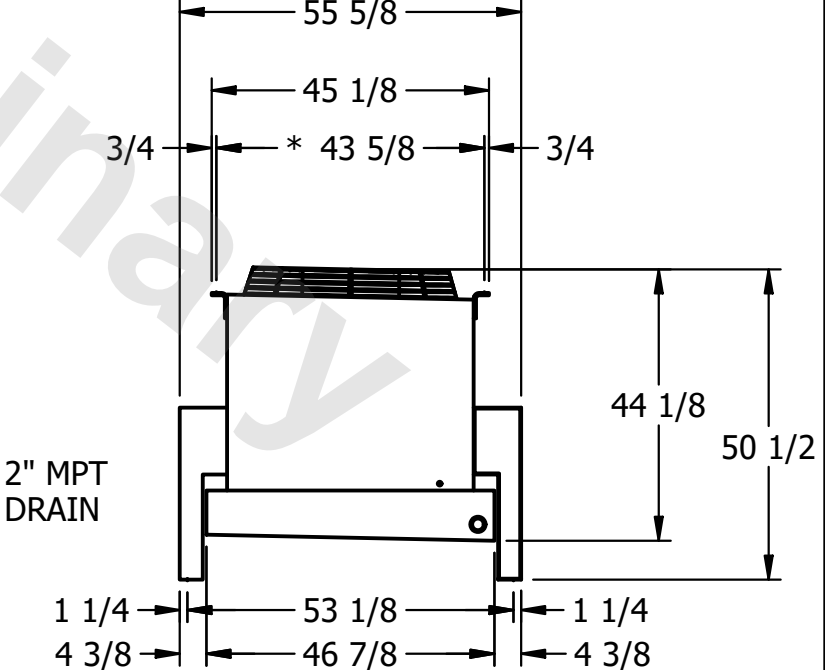
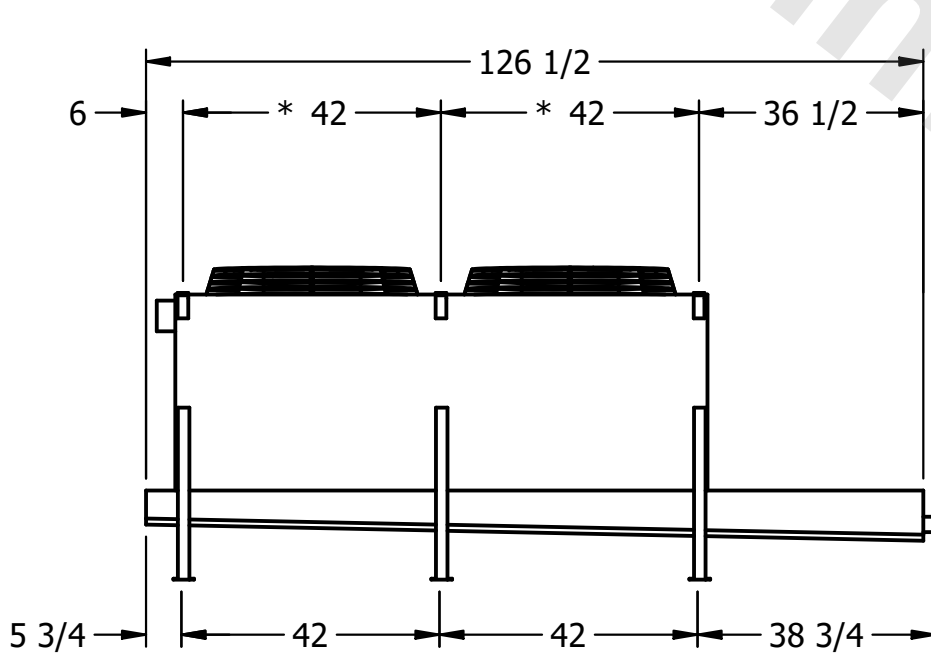

PROJECT	ROOM	SHIPPING WEIGHT 920 lbs+ [420] kg+	OPERATING WEIGHT 1050 lbs+ [480] kg+
---------	------	------------------------------------	--------------------------------------