

CONFIDENTIAL

This document is the property of Evapco, Inc. It should not be copied or disclosed without prior written authorization.

CUSTOMER	MODEL # U-SSTWE4-37R46F0100F1LA	SCALE N.T.S.	DWG. # USSTW4-SE-4L	REV. 0	DATE 5/16/2026
----------	---------------------------------	--------------	---------------------	--------	----------------

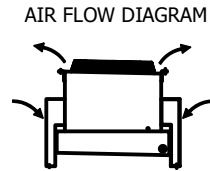
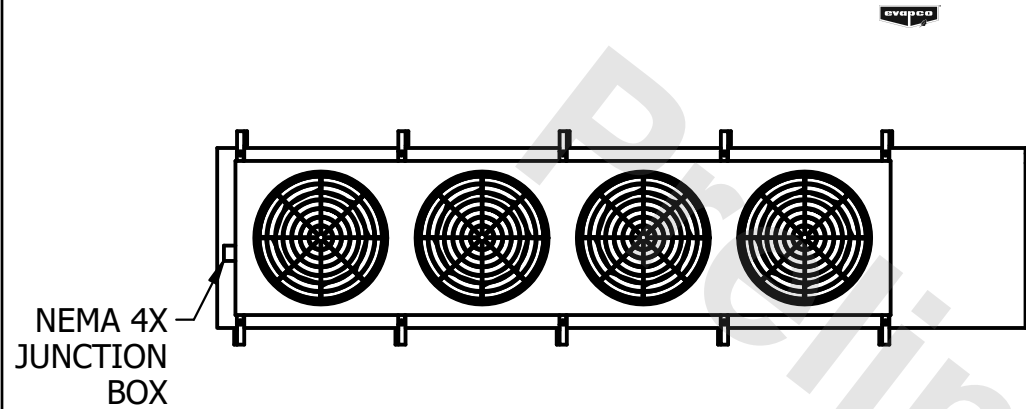

NOTES:

- 1) * = HANGER HOLE LOCATION.
- 2) HANGER HOLES ARE FOR 3/4 INCH THREADED ROD.
- 3) ALL DIMENSIONS ARE FOR REFERENCE AND SHOULD NOT BE USED FOR PREFABRICATION OF PIPING OR SUPPORTS.

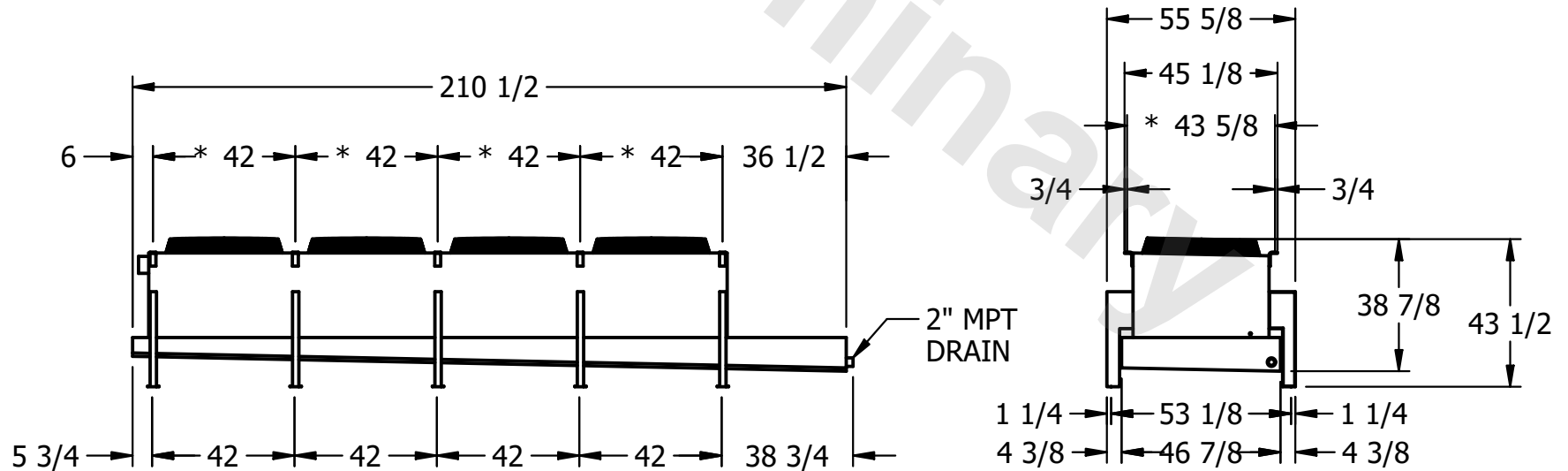

PROJECT	ROOM	SHIPPING WEIGHT 1720 lbs+ [785] kg+	OPERATING WEIGHT 1950 lbs+ [885] kg+
---------	------	-------------------------------------	--------------------------------------