

CONFIDENTIAL

This document is the property of Evapco, Inc. It should not be copied or disclosed without prior written authorization.

CUSTOMER	MODEL # U-SSTWE1-9R66H0050F3KA	SCALE N.T.S.	DWG. # USSTW1-SE-6L	REV. 0	DATE 5/15/2026
----------	--------------------------------	--------------	---------------------	--------	----------------

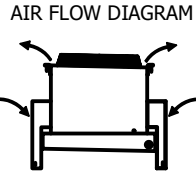

- NOTES:**
- 1) * = HANGER HOLE LOCATION.
 - 2) HANGER HOLES ARE FOR 3/4 INCH THREADED ROD.
 - 3) ALL DIMENSIONS ARE FOR REFERENCE AND SHOULD NOT BE USED FOR PREFABRICATION OF PIPING OR SUPPORTS.

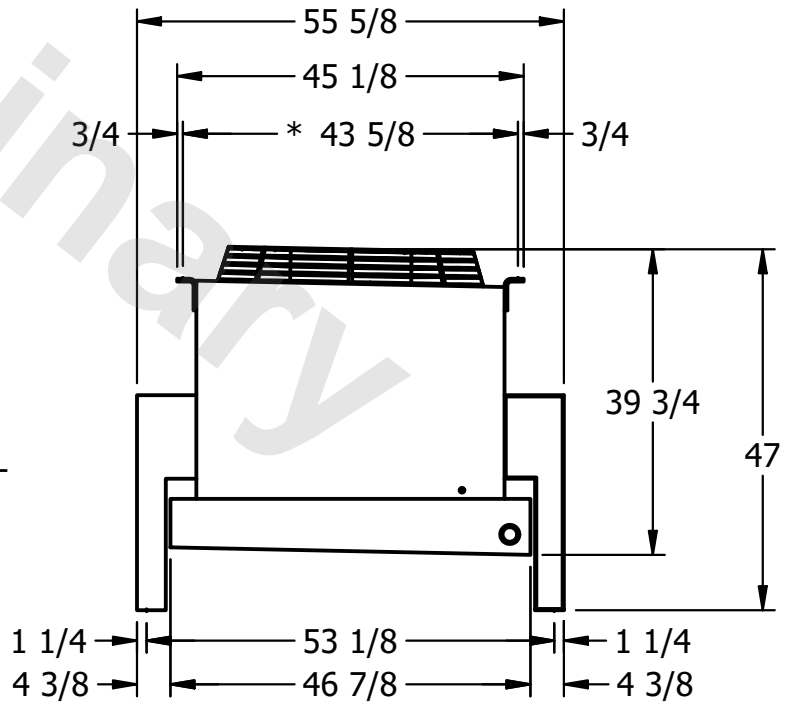
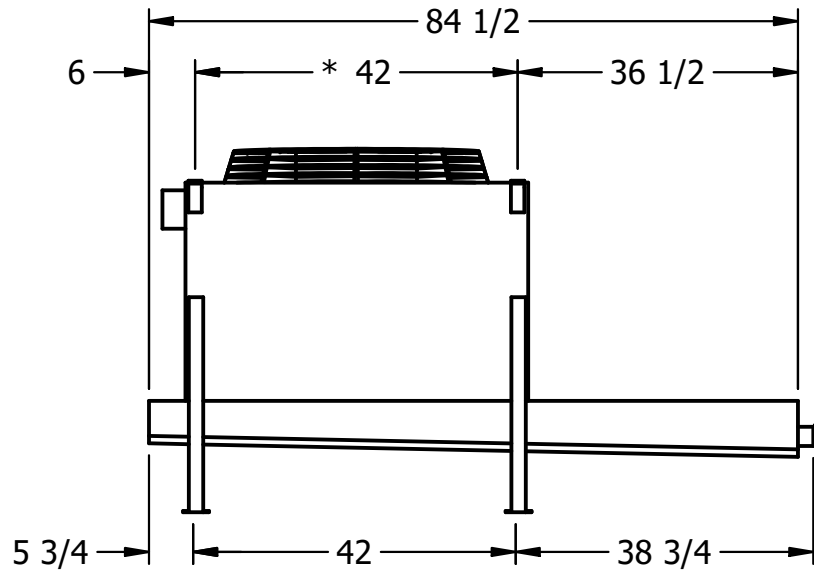

2" MPT DRAIN

PROJECT	ROOM	SHIPPING WEIGHT 730 lbs+ [335] kg+	OPERATING WEIGHT 810 lbs+ [370] kg+
---------	------	------------------------------------	-------------------------------------