

**CONFIDENTIAL**

This document is the property of Evapco, Inc. It should not be copied or disclosed without prior written authorization.

|          |                                |              |                    |        |                |
|----------|--------------------------------|--------------|--------------------|--------|----------------|
| CUSTOMER | MODEL # U-SSTWE1-9S66H0100F1KA | SCALE N.T.S. | DWG. # USSTW1-SE-8 | REV. 0 | DATE 5/15/2026 |
|----------|--------------------------------|--------------|--------------------|--------|----------------|

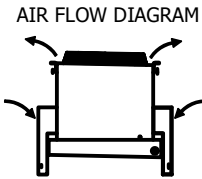

- NOTES:**
- 1) \* = HANGER HOLE LOCATION.
  - 2) HANGER HOLES ARE FOR 3/4 INCH THREADED ROD.
  - 3) ALL DIMENSIONS ARE FOR REFERENCE AND SHOULD NOT BE USED FOR PREFABRICATION OF PIPING OR SUPPORTS.

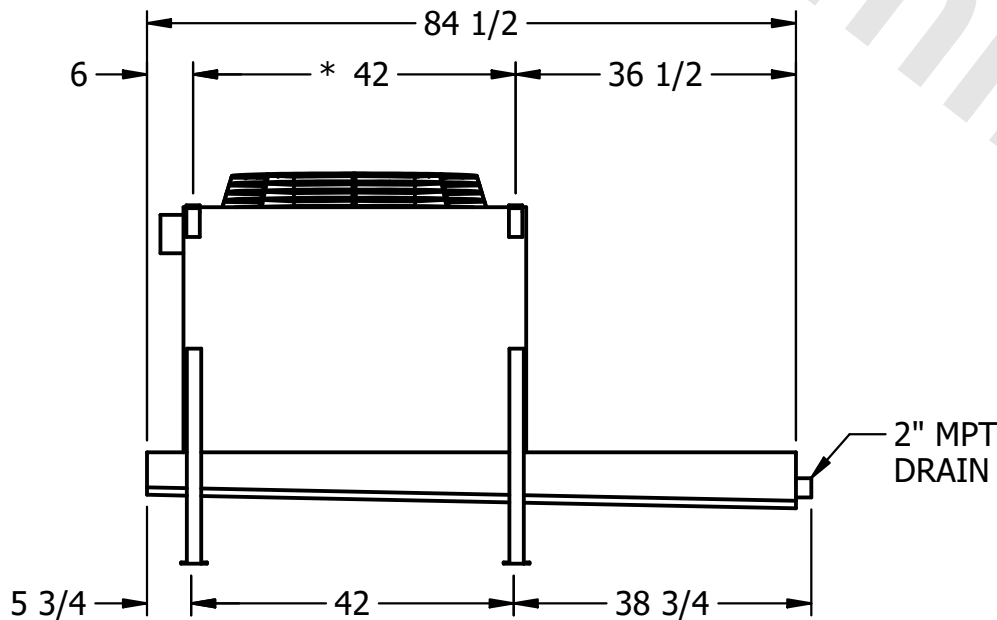

|         |      |                                    |                                     |
|---------|------|------------------------------------|-------------------------------------|
| PROJECT | ROOM | SHIPPING WEIGHT 690 lbs+ [315] kg+ | OPERATING WEIGHT 780 lbs+ [355] kg+ |
|---------|------|------------------------------------|-------------------------------------|