

**CONFIDENTIAL**

This document is the property of Evapco, Inc. It should not be copied or disclosed without prior written authorization.

CUSTOMER	MODEL # U-SSTME3-3244H0150F1LA	SCALE N.T.S.	DWG. # USSTM3-SE-16,18	REV. 0	DATE 7/1/2026
----------	--------------------------------	--------------	------------------------	--------	---------------



- NOTES:**
- 1) \* = HANGER HOLE LOCATION.
  - 2) RIGHT HAND MODEL SHOWN.
  - 3) HANGER HOLES ARE FOR 3/4 INCH THREADED ROD.
  - 4) ALL DIMENSIONS ARE FOR REFERENCE AND SHOULD NOT BE USED FOR PREFABRICATION OF PIPING OR SUPPORTS.

NEMA 4X  
JUNCTION BOX

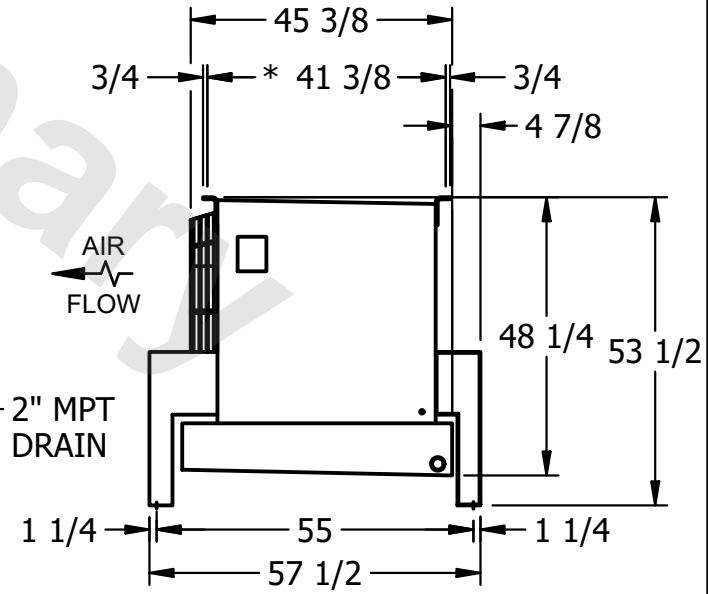
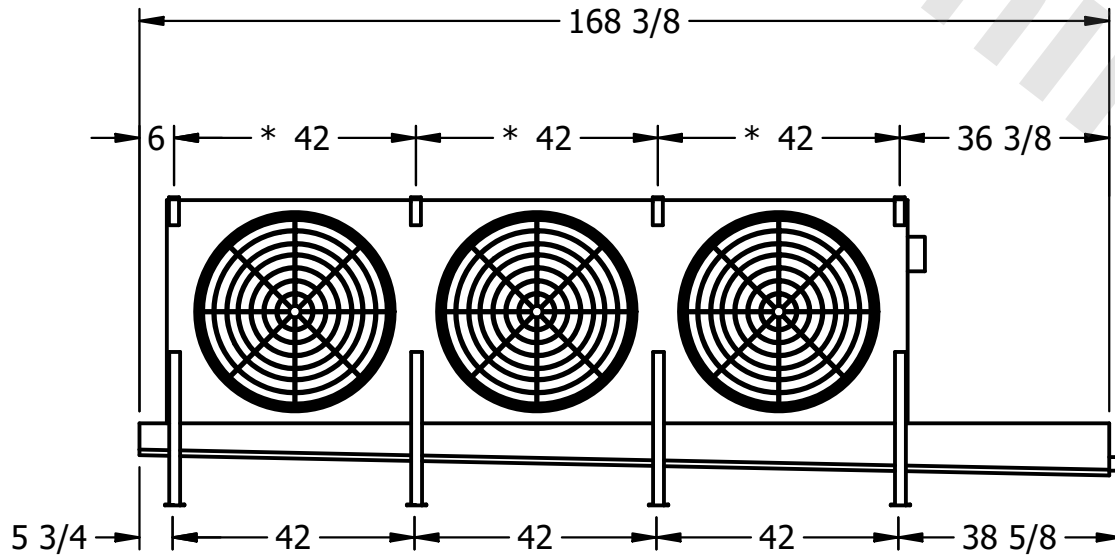

AIR  
FLOW

2" MPT  
DRAIN

PROJECT	ROOM	SHIPPING WEIGHT 1440 lbs+ [655] kg+	OPERATING WEIGHT 1580 lbs+ [720] kg+
---------	------	-------------------------------------	--------------------------------------