

**CONFIDENTIAL**

This document is the property of Evapco, Inc. It should not be copied or disclosed without prior written authorization.

|          |                                |              |                        |        |                |
|----------|--------------------------------|--------------|------------------------|--------|----------------|
| CUSTOMER | MODEL # U-SSTME4-2883F0200C1MA | SCALE N.T.S. | DWG. # USSTM4-SE-12,14 | REV. 0 | DATE 4/28/2026 |
|----------|--------------------------------|--------------|------------------------|--------|----------------|



**NOTES:**

- 1) \* = HANGER HOLE LOCATION.
- 2) RIGHT HAND MODEL SHOWN.
- 3) HANGER HOLES ARE FOR 3/4 INCH THREADED ROD.
- 4) ALL DIMENSIONS ARE FOR REFERENCE AND SHOULD NOT BE USED FOR PREFABRICATION OF PIPING OR SUPPORTS.



NEMA 4X  
JUNCTION BOX

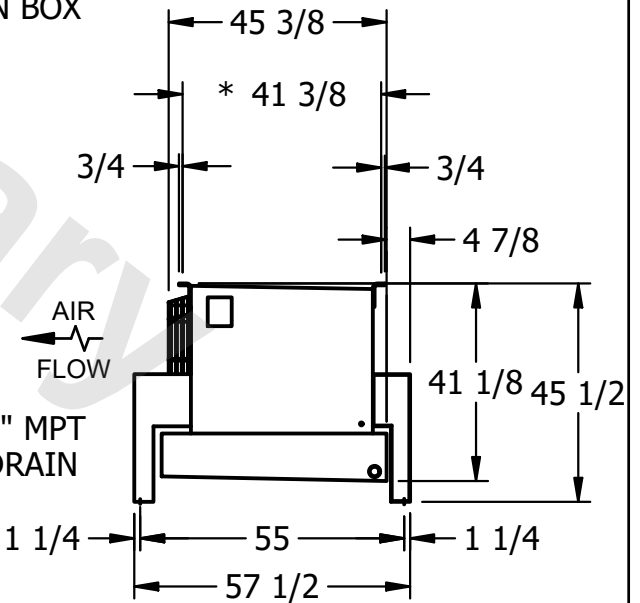

|         |      |                                     |                                      |
|---------|------|-------------------------------------|--------------------------------------|
| PROJECT | ROOM | SHIPPING WEIGHT 1660 lbs+ [755] kg+ | OPERATING WEIGHT 1880 lbs+ [855] kg+ |
|---------|------|-------------------------------------|--------------------------------------|