

CONFIDENTIAL

This document is the property of Evapco, Inc. It should not be copied or disclosed without prior written authorization.

| | | | | | |
|----------|-------------------------------|--------------|------------------------|--------|---------------|
| CUSTOMER | MODEL # U-SSTME1-983F0075F1LA | SCALE N.T.S. | DWG. # USSTM1-SE-16,18 | REV. 0 | DATE 6/5/2026 |
|----------|-------------------------------|--------------|------------------------|--------|---------------|



NOTES:

- 1) * = HANGER HOLE LOCATION.
- 2) RIGHT HAND MODEL SHOWN.
- 3) HANGER HOLES ARE FOR 3/4 INCH THREADED ROD.
- 4) ALL DIMENSIONS ARE FOR REFERENCE AND SHOULD NOT BE USED FOR PREFABRICATION OF PIPING OR SUPPORTS.

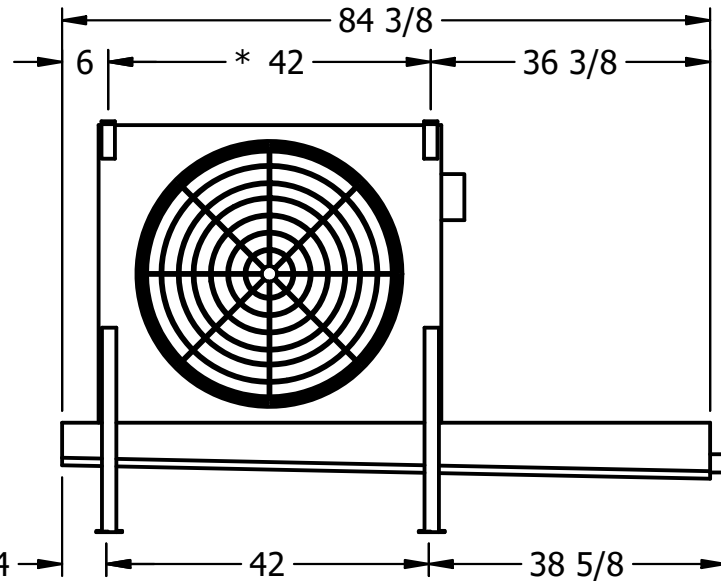

| | | | |
|---------|------|------------------------------------|-------------------------------------|
| PROJECT | ROOM | SHIPPING WEIGHT 550 lbs+ [250] kg+ | OPERATING WEIGHT 630 lbs+ [290] kg+ |
|---------|------|------------------------------------|-------------------------------------|