

CONFIDENTIAL

This document is the property of Evapco, Inc. It should not be copied or disclosed without prior written authorization.

CUSTOMER	MODEL # U-SSTME1-1163H0150F1LA	SCALE N.T.S.	DWG. # USSTM1-SE-16,18	REV. 0	DATE 5/30/2026
----------	--------------------------------	--------------	------------------------	--------	----------------



NOTES:

- 1) * = HANGER HOLE LOCATION.
- 2) RIGHT HAND MODEL SHOWN.
- 3) HANGER HOLES ARE FOR 3/4 INCH THREADED ROD.
- 4) ALL DIMENSIONS ARE FOR REFERENCE AND SHOULD NOT BE USED FOR PREFABRICATION OF PIPING OR SUPPORTS.



2" MPT DRAIN

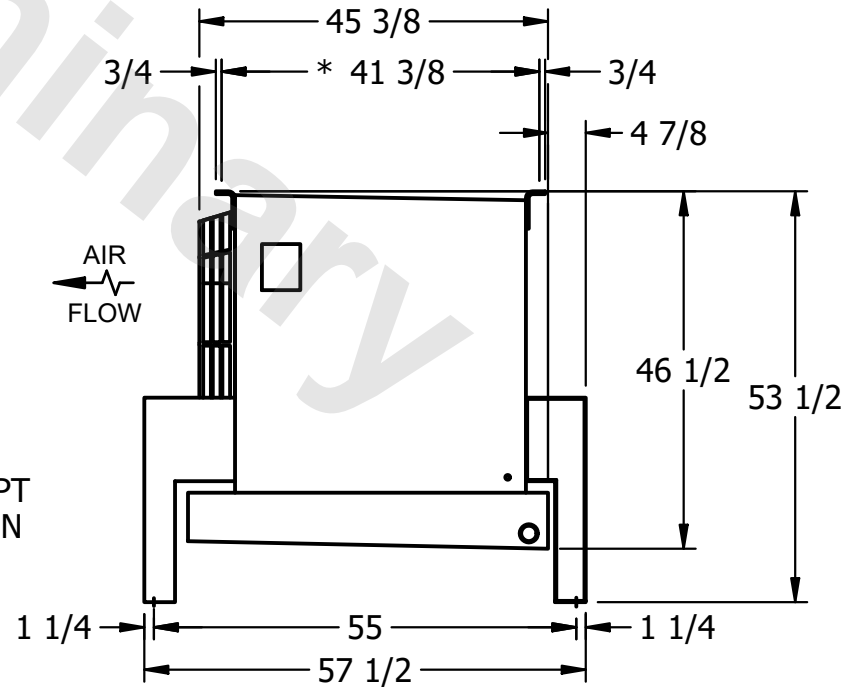

PROJECT	ROOM	SHIPPING WEIGHT 620 lbs+ [285] kg+	OPERATING WEIGHT 680 lbs+ [310] kg+
---------	------	------------------------------------	-------------------------------------