

**CONFIDENTIAL**

This document is the property of Evapco, Inc. It should not be copied or disclosed without prior written authorization.

CUSTOMER	MODEL # U-SSTME1-7103F0075C1LA	SCALE N.T.S.	DWG. # USSTM1-SE-12,14	REV. 0	DATE 4/9/2026
----------	--------------------------------	--------------	------------------------	--------	---------------

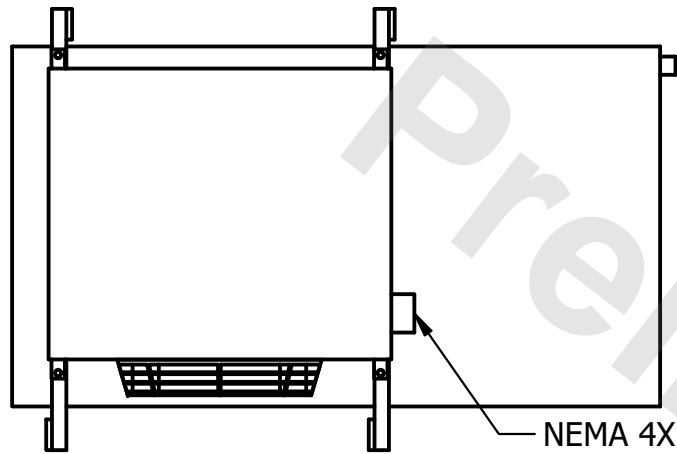

**NOTES:**

- 1) \* = HANGER HOLE LOCATION.
- 2) RIGHT HAND MODEL SHOWN.
- 3) HANGER HOLES ARE FOR 3/4 INCH THREADED ROD.
- 4) ALL DIMENSIONS ARE FOR REFERENCE AND SHOULD NOT BE USED FOR PREFABRICATION OF PIPING OR SUPPORTS.

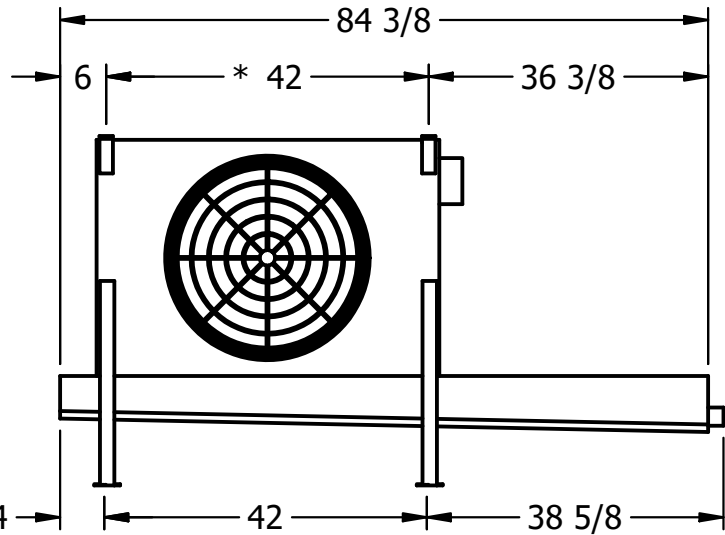

2" MPT DRAIN



AIR FLOW

PROJECT	ROOM	SHIPPING WEIGHT 520 lbs+ [240] kg+	OPERATING WEIGHT 590 lbs+ [270] kg+
---------	------	------------------------------------	-------------------------------------