

CONFIDENTIAL

This document is the property of Evapco, Inc. It should not be copied or disclosed without prior written authorization.

CUSTOMER	MODEL # U-SSTME1-14103F0150H1JA	SCALE N.T.S.	DWG. # USSTM1-SE-24	REV. 0	DATE 4/7/2026
----------	---------------------------------	--------------	---------------------	--------	---------------



NEMA 4X
JUNCTION BOX

NOTES:

- 1) * = HANGER HOLE LOCATION.
- 2) RIGHT HAND MODEL SHOWN.
- 3) HANGER HOLES ARE FOR 3/4 INCH THREADED ROD.
- 4) ALL DIMENSIONS ARE FOR REFERENCE AND SHOULD NOT BE USED FOR PREFABRICATION OF PIPING OR SUPPORTS.

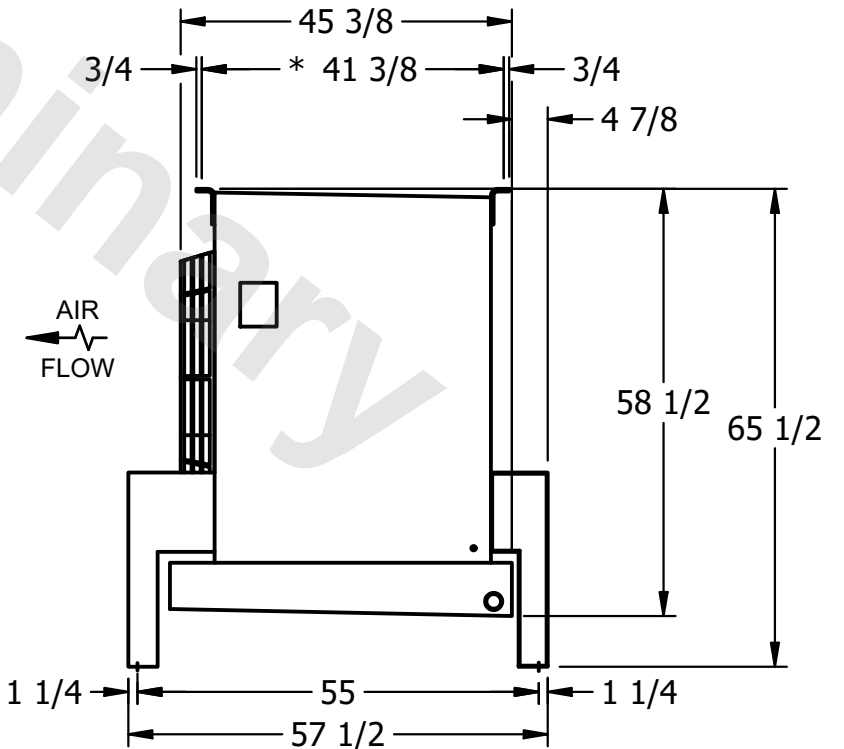

2" MPT
DRAIN

PROJECT	ROOM	SHIPPING WEIGHT 750 lbs+ [345] kg+	OPERATING WEIGHT 890 lbs+ [405] kg+
---------	------	------------------------------------	-------------------------------------