

CONFIDENTIAL

This document is the property of Evapco, Inc. It should not be copied or disclosed without prior written authorization.

| | | | | | |
|----------|--------------------------------|--------------|---------------------|--------|----------------|
| CUSTOMER | MODEL # U-SSTME2-2886H0100F1LA | SCALE N.T.S. | DWG. # USSTM2-SE-24 | REV. 0 | DATE 4/29/2026 |
|----------|--------------------------------|--------------|---------------------|--------|----------------|



NOTES:

- 1) * = HANGER HOLE LOCATION.
- 2) RIGHT HAND MODEL SHOWN.
- 3) HANGER HOLES ARE FOR 3/4 INCH THREADED ROD.
- 4) ALL DIMENSIONS ARE FOR REFERENCE AND SHOULD NOT BE USED FOR PREFABRICATION OF PIPING OR SUPPORTS.

NEMA 4X
JUNCTION BOX



AIR
FLOW

2" MPT
DRAIN

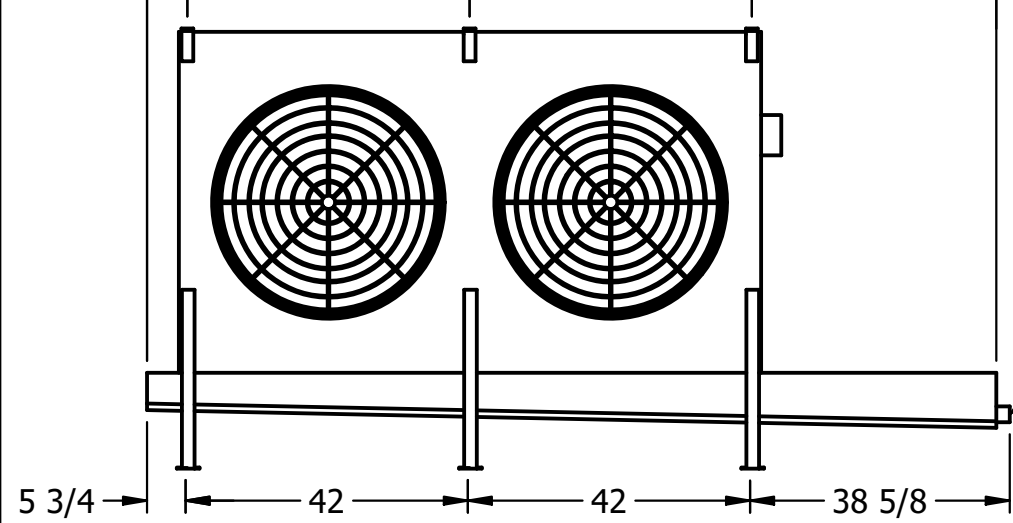

| | | | |
|---------|------|-------------------------------------|--------------------------------------|
| PROJECT | ROOM | SHIPPING WEIGHT 1850 lbs+ [840] kg+ | OPERATING WEIGHT 2190 lbs+ [995] kg+ |
|---------|------|-------------------------------------|--------------------------------------|