

CONFIDENTIAL

This document is the property of Evapco, Inc. It should not be copied or disclosed without prior written authorization.

CUSTOMER	MODEL # U-SSTME2-2183H0033F1KA	SCALE N.T.S.	DWG. # USSTM2-SE-16,18	REV. 0	DATE 4/27/2026
----------	--------------------------------	--------------	------------------------	--------	----------------



NOTES:

- 1) * = HANGER HOLE LOCATION.
- 2) RIGHT HAND MODEL SHOWN.
- 3) HANGER HOLES ARE FOR 3/4 INCH THREADED ROD.
- 4) ALL DIMENSIONS ARE FOR REFERENCE AND SHOULD NOT BE USED FOR PREFABRICATION OF PIPING OR SUPPORTS.

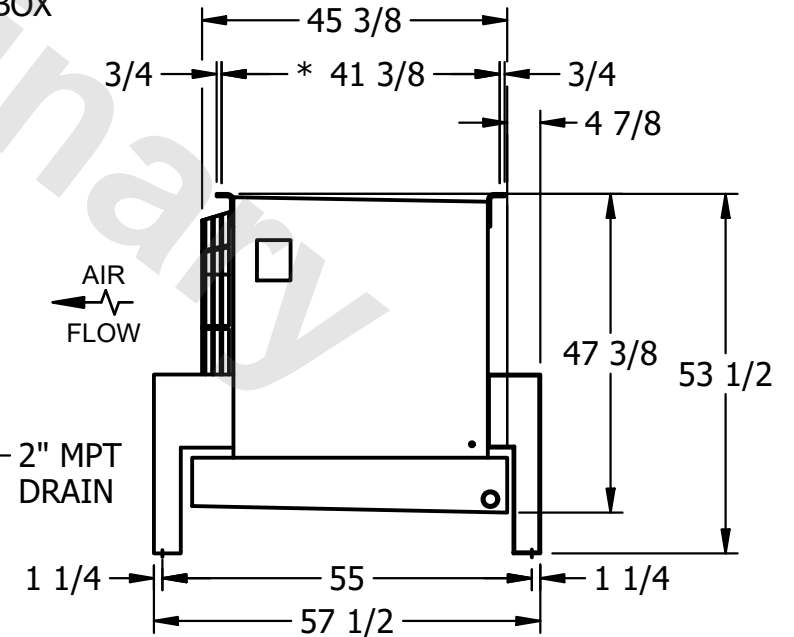

PROJECT	ROOM	SHIPPING WEIGHT 1230 lbs+ [560] kg+	OPERATING WEIGHT 1390 lbs+ [635] kg+
---------	------	-------------------------------------	--------------------------------------