

CONFIDENTIAL

This document is the property of Evapco, Inc. It should not be copied or disclosed without prior written authorization.

CUSTOMER	MODEL # U-SSTME1-9104F0075F1LA	SCALE N.T.S.	DWG. # USSTM1-SE-16,18	REV. 0	DATE 6/3/2026
----------	--------------------------------	--------------	------------------------	--------	---------------



NOTES:

- 1) * = HANGER HOLE LOCATION.
- 2) RIGHT HAND MODEL SHOWN.
- 3) HANGER HOLES ARE FOR 3/4 INCH THREADED ROD.
- 4) ALL DIMENSIONS ARE FOR REFERENCE AND SHOULD NOT BE USED FOR PREFABRICATION OF PIPING OR SUPPORTS.



2" MPT DRAIN

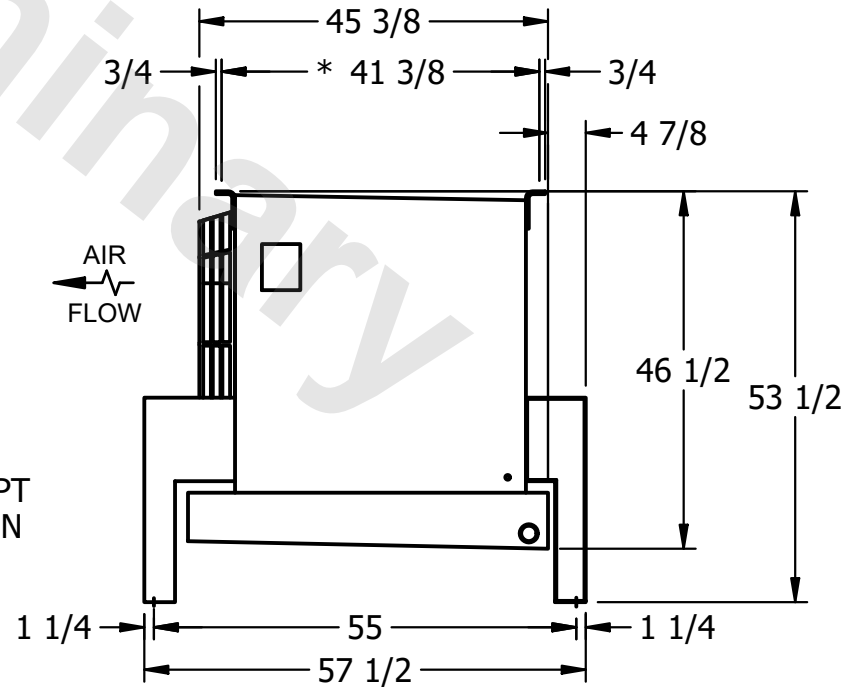

PROJECT	ROOM	SHIPPING WEIGHT 630 lbs+ [290] kg+	OPERATING WEIGHT 740 lbs+ [340] kg+
---------	------	------------------------------------	-------------------------------------