

CONFIDENTIAL

This document is the property of Evapco, Inc. It should not be copied or disclosed without prior written authorization.

CUSTOMER	MODEL # U-SSTME3-2564H0033C1KA	SCALE N.T.S.	DWG. # USSTM3-SE-12,14	REV. 0	DATE 3/4/2026
----------	--------------------------------	--------------	------------------------	--------	---------------

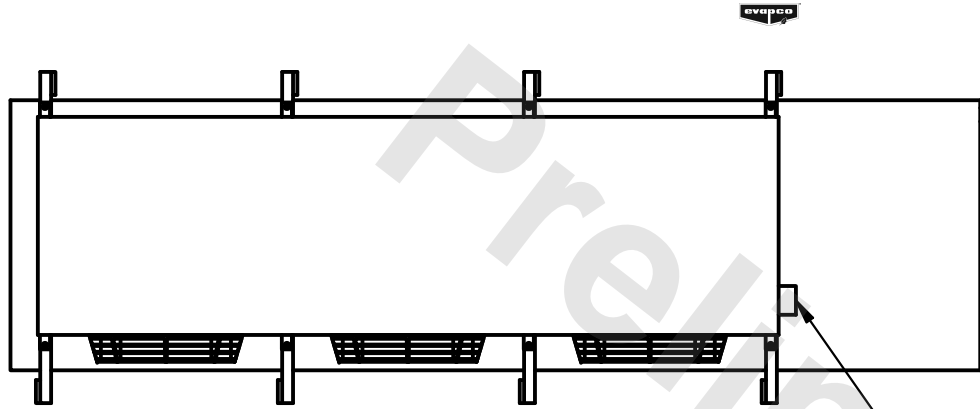

NEMA 4X
JUNCTION BOX

NOTES:

- 1) * = HANGER HOLE LOCATION.
- 2) RIGHT HAND MODEL SHOWN.
- 3) HANGER HOLES ARE FOR 3/4 INCH THREADED ROD.
- 4) ALL DIMENSIONS ARE FOR REFERENCE AND SHOULD NOT BE USED FOR PREFABRICATION OF PIPING OR SUPPORTS.

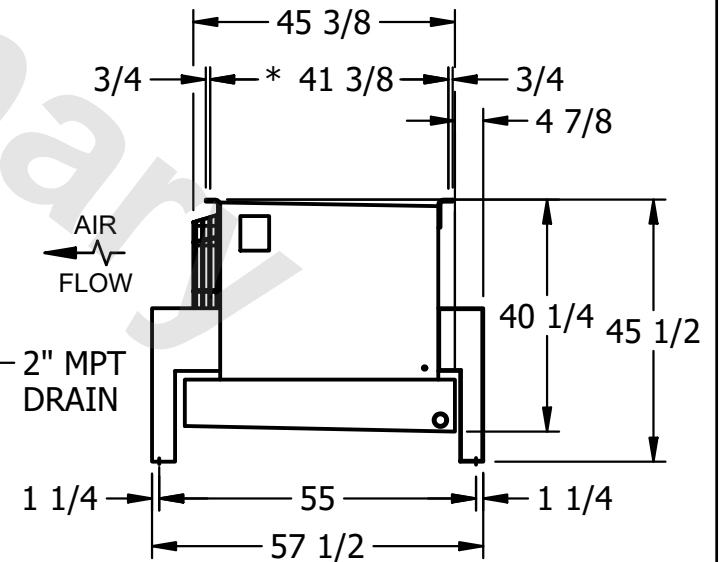
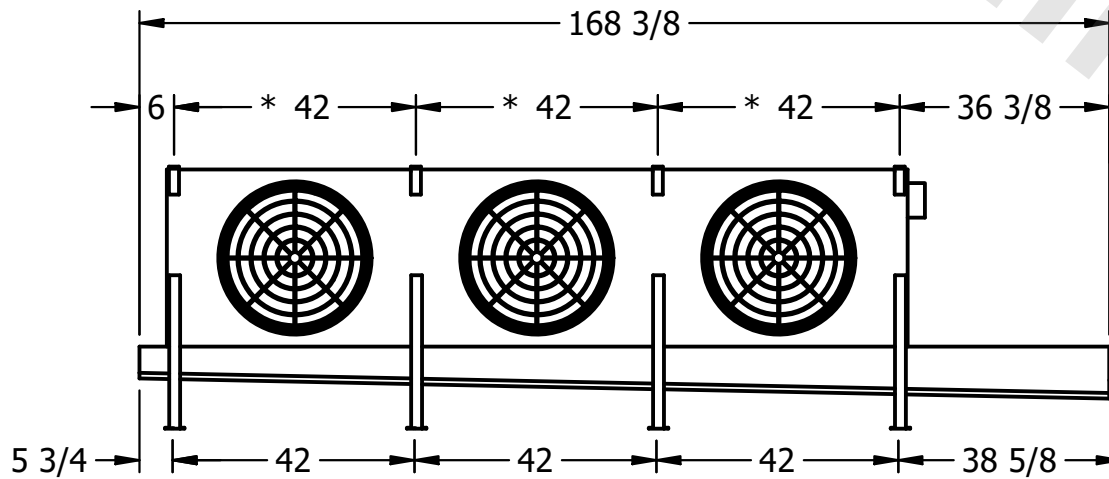

PROJECT	ROOM	SHIPPING WEIGHT 1590 lbs+ [725] kg+	OPERATING WEIGHT 1760 lbs+ [800] kg+
---------	------	-------------------------------------	--------------------------------------