

**CONFIDENTIAL**

This document is the property of Evapco, Inc. It should not be copied or disclosed without prior written authorization.

CUSTOMER	MODEL # U-SSTME1-1146F0033F1KA	SCALE N.T.S.	DWG. # USSTM1-SE-16,18	REV. 0	DATE 5/30/2026
----------	--------------------------------	--------------	------------------------	--------	----------------



NEMA 4X  
JUNCTION BOX

**NOTES:**

- 1) \* = HANGER HOLE LOCATION.
- 2) RIGHT HAND MODEL SHOWN.
- 3) HANGER HOLES ARE FOR 3/4 INCH THREADED ROD.
- 4) ALL DIMENSIONS ARE FOR REFERENCE AND SHOULD NOT BE USED FOR PREFABRICATION OF PIPING OR SUPPORTS.



2" MPT  
DRAIN

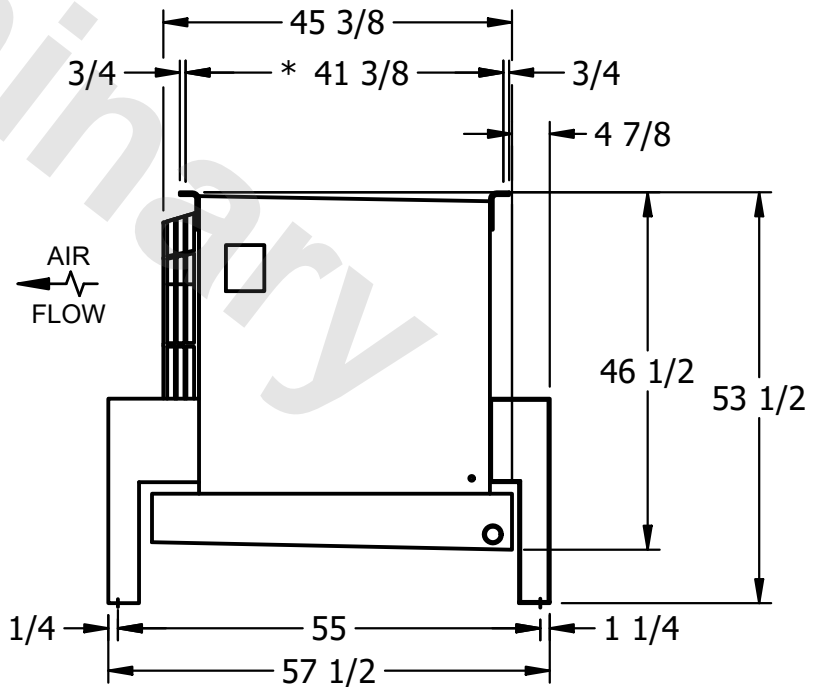

AIR  
FLOW

PROJECT	ROOM	SHIPPING WEIGHT 570 lbs+ [260] kg+	OPERATING WEIGHT 630 lbs+ [290] kg+
---------	------	------------------------------------	-------------------------------------