

**CONFIDENTIAL**

This document is the property of Evapco, Inc. It should not be copied or disclosed without prior written authorization.

CUSTOMER	MODEL # U-SSTME3-2584F0200C1MA	SCALE N.T.S.	DWG. # USSTM3-SE-12,14	REV. 0	DATE 6/30/2026
----------	--------------------------------	--------------	------------------------	--------	----------------



NEMA 4X  
JUNCTION BOX

- NOTES:**
- 1) \* = HANGER HOLE LOCATION.
  - 2) RIGHT HAND MODEL SHOWN.
  - 3) HANGER HOLES ARE FOR 3/4 INCH THREADED ROD.
  - 4) ALL DIMENSIONS ARE FOR REFERENCE AND SHOULD NOT BE USED FOR PREFABRICATION OF PIPING OR SUPPORTS.

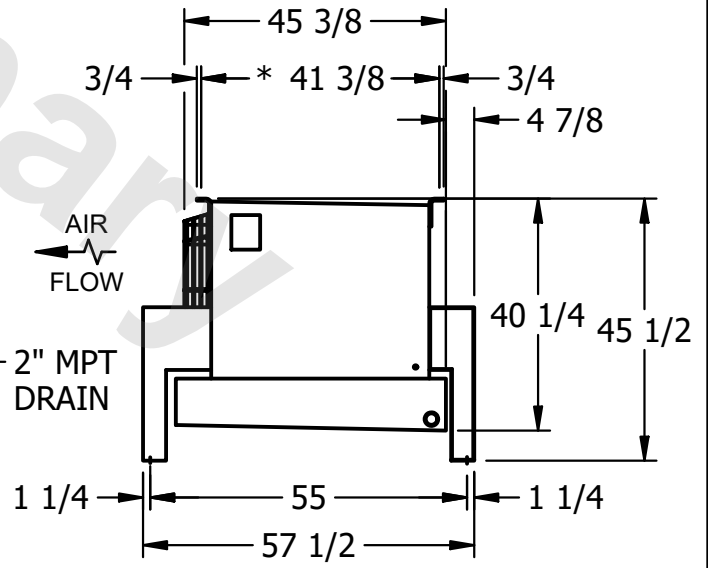

PROJECT	ROOM	SHIPPING WEIGHT 1500 lbs+ [685] kg+	OPERATING WEIGHT 1730 lbs+ [785] kg+
---------	------	-------------------------------------	--------------------------------------