

UNIT	CONDENSER	
MODEL #	PMRC-1201	SCALE NTS

EVAPCO, INC.

DWG. #	CEWR12C2410-DRB-ST	REV	-
SERIAL #		DATE:	4/25/2026

- NOTES:**
- (M)- FAN MOTOR LOCATION.
 - MPT DENOTES MALE PIPE THREAD
FPT DENOTES FEMALE PIPE THREAD
BFW DENOTES BEVELED FOR WELDING
GVD DENOTES GROOVED
FLG DENOTES FLANGE
PE DENOTES PLAIN END
 - +UNIT WEIGHT DOES NOT INCLUDE ACCESSORIES (SEE ACCESSORY DRAWINGS).
 - 3/4" [19mm] DIA. MOUNTING HOLES. REFER TO RECOMMENDED STEEL SUPPORT DRAWING.
 - MAKE-UP WATER PRESSURE 20 psi [137 kPa] MIN, 50 psi [344 kPa] MAX.
 - DIMENSIONS LISTED AS FOLLOWS:
ENGLISH FT-IN
[METRIC] [mm]
 - * - APPROXIMATE DIMENSIONS DO NOT USE FOR PRE-FABRICATION OF CONNECTING PIPING.

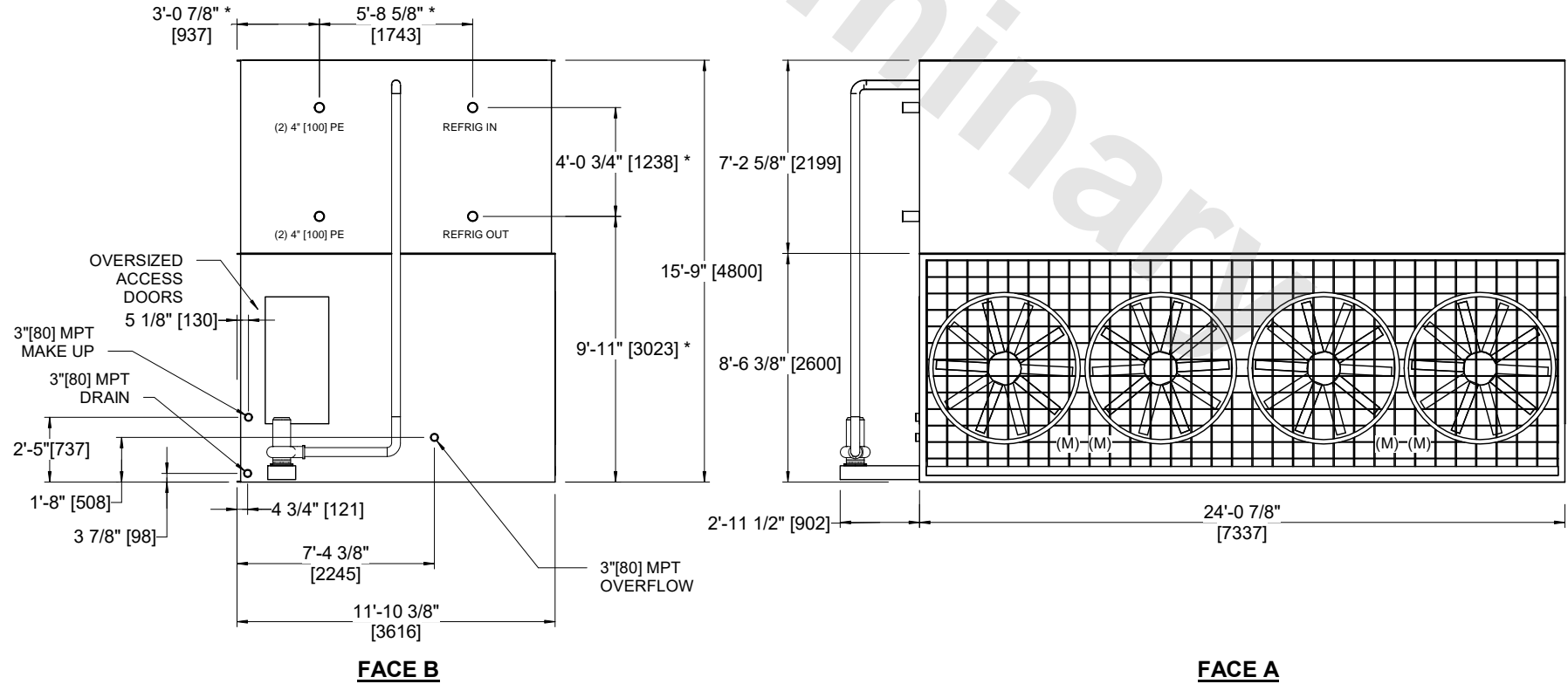
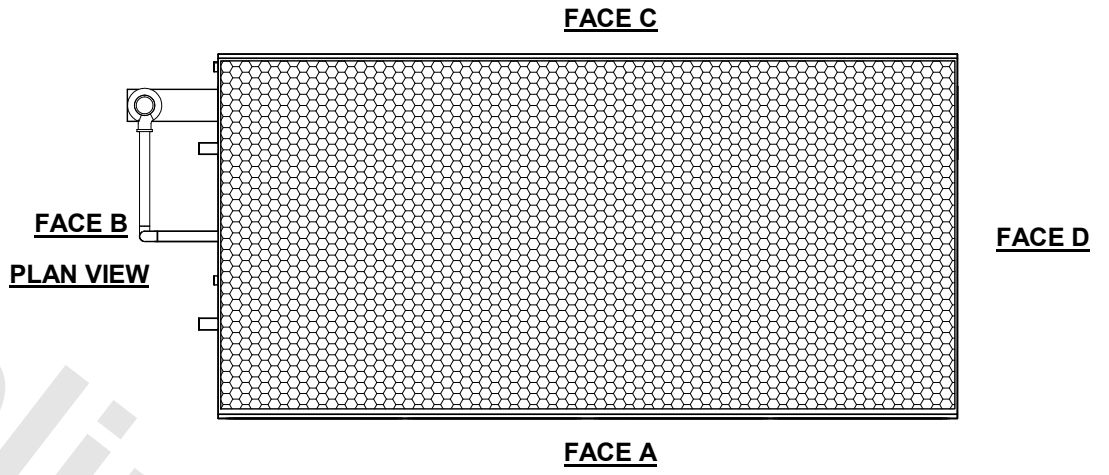

SHIPPING WEIGHT	40080 lbs+ [18180] kg+	OPERATING WEIGHT	50710 lbs+ [23005] kg+	HEAVIEST SECTION WEIGHT	28300 lbs+ [12840] kg+	NO. OF SHIPPING SECTIONS	2	DRAWN BY:	JLG
-----------------	------------------------	------------------	------------------------	-------------------------	------------------------	--------------------------	---	-----------	-----