

|         |           |           |
|---------|-----------|-----------|
| UNIT    | CONDENSER |           |
| MODEL # | PMRC-1180 | SCALE NTS |

# EVAPCO, INC.

|          |                    |       |           |
|----------|--------------------|-------|-----------|
| DWG. #   | CEWR12C2412-DRB-ST | REV   | -         |
| SERIAL # |                    | DATE: | 4/25/2026 |

- NOTES:**
- (M)- FAN MOTOR LOCATION.
  - MPT DENOTES MALE PIPE THREAD  
FPT DENOTES FEMALE PIPE THREAD  
BFW DENOTES BEVELED FOR WELDING  
GVD DENOTES GROOVED  
FLG DENOTES FLANGE  
PE DENOTES PLAIN END
  - +UNIT WEIGHT DOES NOT INCLUDE ACCESSORIES (SEE ACCESSORY DRAWINGS).
  - 3/4" [19mm] DIA. MOUNTING HOLES. REFER TO RECOMMENDED STEEL SUPPORT DRAWING.
  - MAKE-UP WATER PRESSURE 20 psi [137 kPa] MIN, 50 psi [344 kPa] MAX.
  - DIMENSIONS LISTED AS FOLLOWS:  
ENGLISH FT-IN  
[METRIC] [mm]
  - \* - APPROXIMATE DIMENSIONS DO NOT USE FOR PRE-FABRICATION OF CONNECTING PIPING.

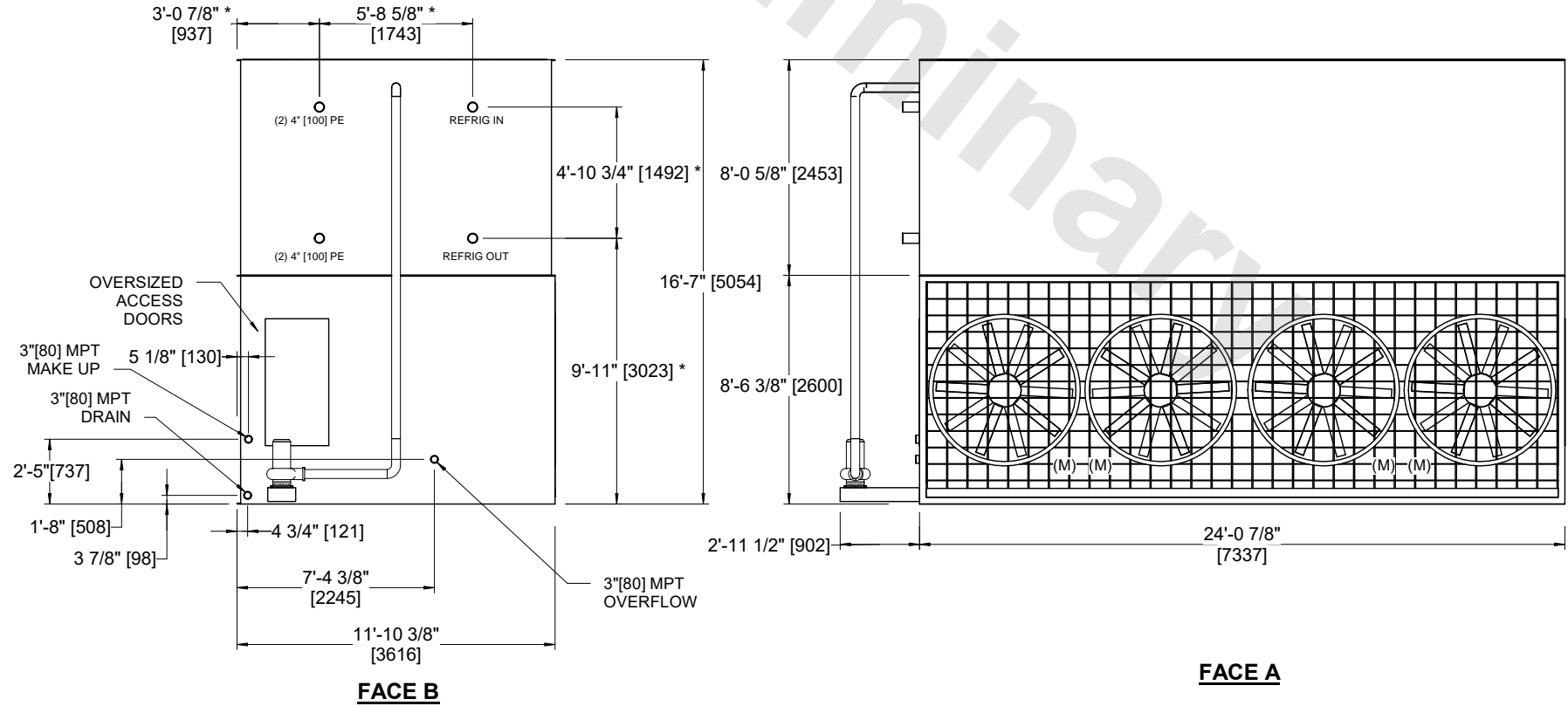
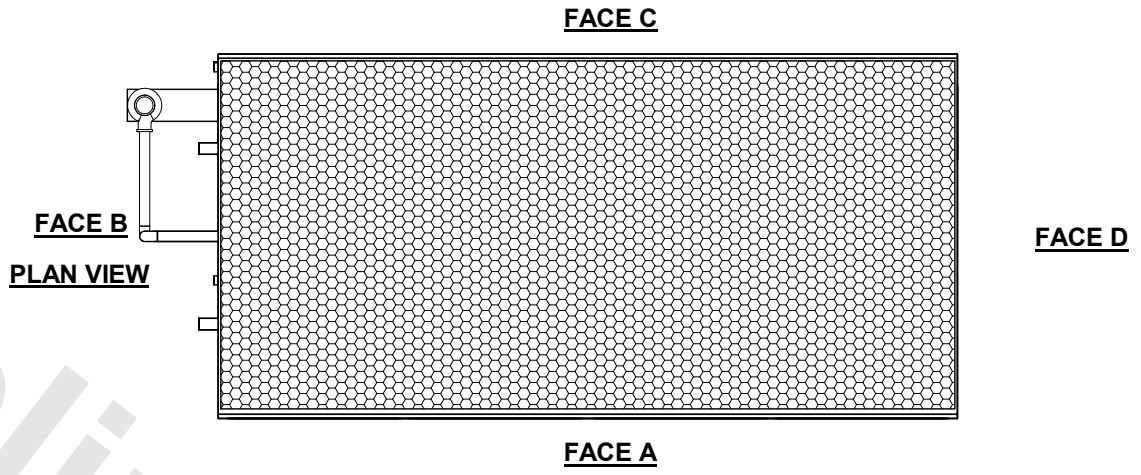

|                 |                        |                  |                        |                         |                        |                          |   |           |     |
|-----------------|------------------------|------------------|------------------------|-------------------------|------------------------|--------------------------|---|-----------|-----|
| SHIPPING WEIGHT | 44620 lbs+ [20240] kg+ | OPERATING WEIGHT | 55450 lbs+ [25155] kg+ | HEAVIEST SECTION WEIGHT | 33160 lbs+ [15045] kg+ | NO. OF SHIPPING SECTIONS | 2 | DRAWN BY: | JLG |
|-----------------|------------------------|------------------|------------------------|-------------------------|------------------------|--------------------------|---|-----------|-----|