

|         |               |           |
|---------|---------------|-----------|
| UNIT    | CONDENSER     |           |
| MODEL # | eco-PMRC-1916 | SCALE NTS |

# EVAPCO, INC.

|          |                   |       |          |
|----------|-------------------|-------|----------|
| DWG. #   | CEWR124008-DRA-ST | REV   | -        |
| SERIAL # |                   | DATE: | 4/6/2026 |

- NOTES:**
- (M)- FAN MOTOR LOCATION.
  - MPT DENOTES MALE PIPE THREAD  
FPT DENOTES FEMALE PIPE THREAD  
BFW DENOTES BEVELED FOR WELDING  
GVD DENOTES GROOVED  
FLG DENOTES FLANGE  
PE DENOTES PLAIN END
  - +UNIT WEIGHT DOES NOT INCLUDE ACCESSORIES (SEE ACCESSORY DRAWINGS).
  - 3/4" [19mm] DIA. MOUNTING HOLES. REFER TO RECOMMENDED STEEL SUPPORT DRAWING.
  - MAKE-UP WATER PRESSURE 20 psi [137 kPa] MIN, 50 psi [344 kPa] MAX.
  - DIMENSIONS LISTED AS FOLLOWS:  
ENGLISH FT-IN  
[METRIC] [mm]
  - \* - APPROXIMATE DIMENSIONS DO NOT USE FOR PRE-FABRICATION OF CONNECTING PIPING.

**FACE B**  
**PLAN VIEW**

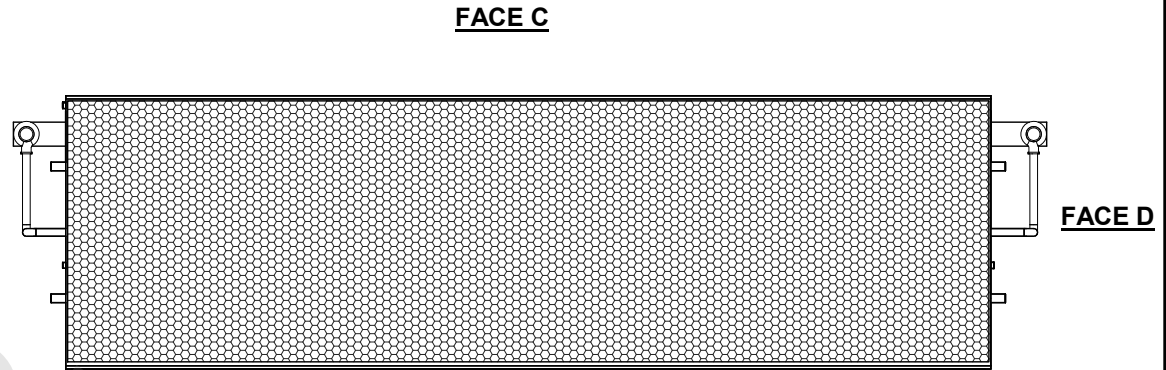

**FACE A**

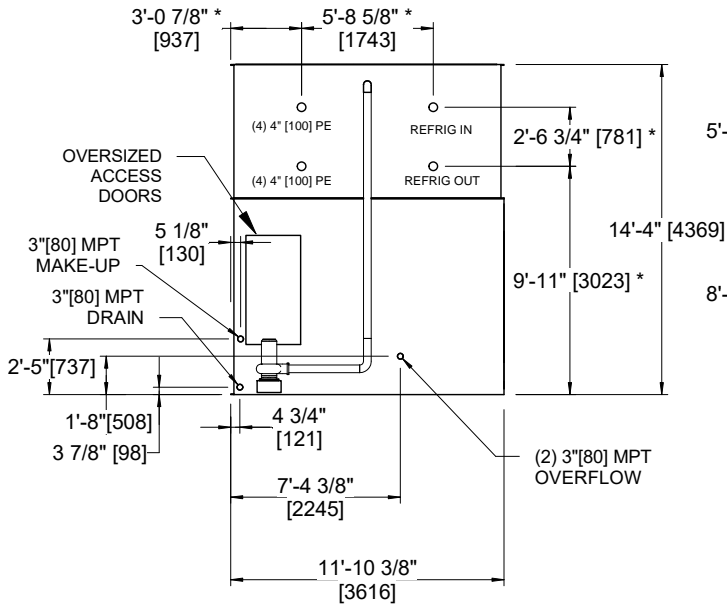

**FACE B**

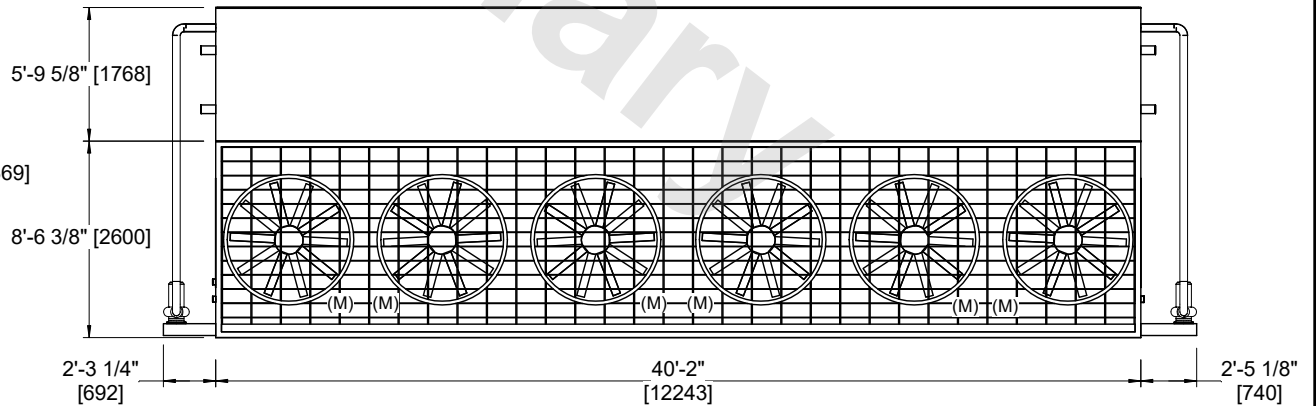

**FACE A**

|                 |                        |                  |                        |                         |                        |                          |   |           |     |
|-----------------|------------------------|------------------|------------------------|-------------------------|------------------------|--------------------------|---|-----------|-----|
| SHIPPING WEIGHT | 70240 lbs+ [31865] kg+ | OPERATING WEIGHT | 86320 lbs+ [39155] kg+ | HEAVIEST SECTION WEIGHT | 26460 lbs+ [12005] kg+ | NO. OF SHIPPING SECTIONS | 3 | DRAWN BY: | JLG |
|-----------------|------------------------|------------------|------------------------|-------------------------|------------------------|--------------------------|---|-----------|-----|