

**CONFIDENTIAL**

This document is the property of Evapco, Inc. It should not be copied or disclosed without prior written authorization.

|          |                                 |              |                         |        |               |
|----------|---------------------------------|--------------|-------------------------|--------|---------------|
| CUSTOMER | MODEL # U-EJETME3-2886F0075F1LA | SCALE N.T.S. | DWG. # UEJETM3-SE-16,18 | REV. 0 | DATE 5/1/2026 |
|----------|---------------------------------|--------------|-------------------------|--------|---------------|



**NOTES:**

- 1) \* = HANGER HOLE LOCATION.
- 2) RIGHT HAND MODEL SHOWN.
- 3) HANGER HOLES ARE FOR 3/4 INCH THREADED ROD.
- 4) WATER DEFROST ADDS 1 3/4" INCHES TO HEIGHT OF STANDARD UNIT AND CHANGES DRAIN SIZE.
- 5) ALL DIMENSIONS ARE FOR REFERENCE AND SHOULD NOT BE USED FOR PREFABRICATION OF PIPING OR SUPPORTS.
- 6) \*\*= HEIGHT OF SUCTION HEADER AND INSTALLED THERMOWELL FITTING ABOVE CABINET. CUSTOMER IS RESPONSIBLE TO ACCOUNT FOR ADDITIONAL HEIGHT NECESSARY FOR RTD AND ACCESS.

NEMA 4X  
JUNCTION BOX

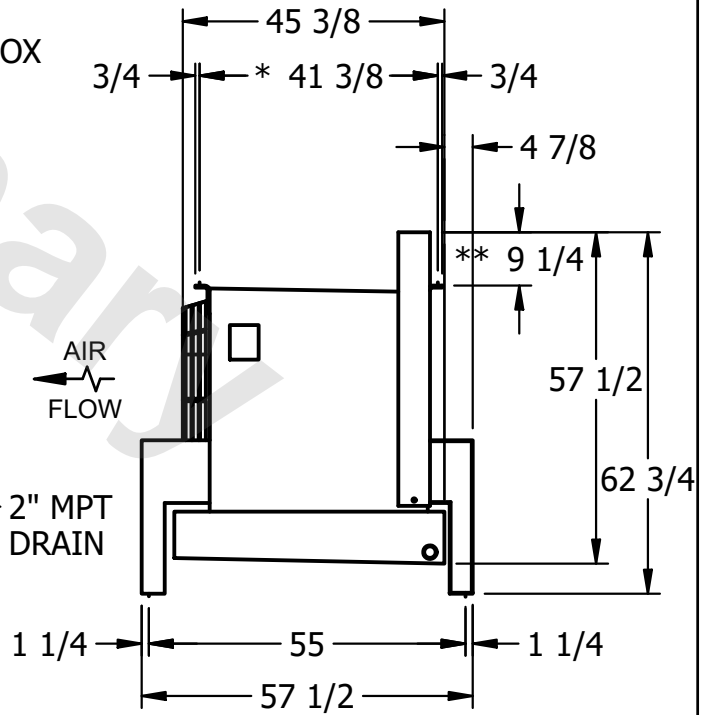
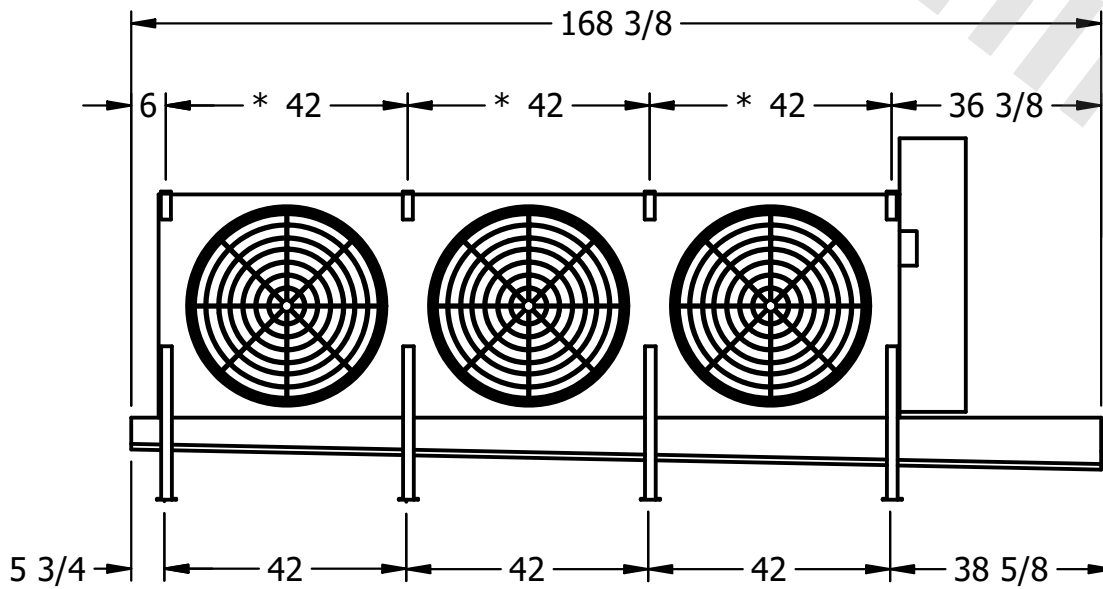

2" MPT  
DRAIN

|         |      |                                     |                                      |
|---------|------|-------------------------------------|--------------------------------------|
| PROJECT | ROOM | SHIPPING WEIGHT 1580 lbs+ [720] kg+ | OPERATING WEIGHT 1920 lbs+ [875] kg+ |
|---------|------|-------------------------------------|--------------------------------------|