

CONFIDENTIAL

This document is the property of Evapco, Inc. It should not be copied or disclosed without prior written authorization.

CUSTOMER	MODEL # U-EJETME1-866F0050C1KA	SCALE N.T.S.	DWG. # UEJETM1-SE-12,14	REV. 0	DATE 2/21/2026
----------	--------------------------------	--------------	-------------------------	--------	----------------

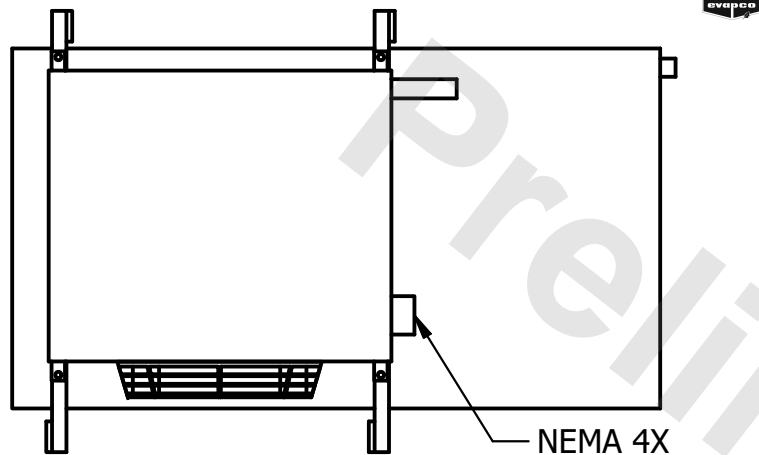

NEMA 4X
JUNCTION BOX

NOTES:

- 1) * = HANGER HOLE LOCATION.
- 2) RIGHT HAND MODEL SHOWN.
- 3) HANGER HOLES ARE FOR 3/4 INCH THREADED ROD.
- 4) WATER DEFROST ADDS 1 3/4" INCHES TO HEIGHT OF STANDARD UNIT AND CHANGES DRAIN SIZE.
- 5) ALL DIMENSIONS ARE FOR REFERENCE AND SHOULD NOT BE USED FOR PREFABRICATION OF PIPING OR SUPPORTS.
- 6) **= HEIGHT OF SUCTION HEADER AND INSTALLED THERMOWELL FITTING ABOVE CABINET. CUSTOMER IS RESPONSIBLE TO ACCOUNT FOR ADDITIONAL HEIGHT NECESSARY FOR RTD AND ACCESS.

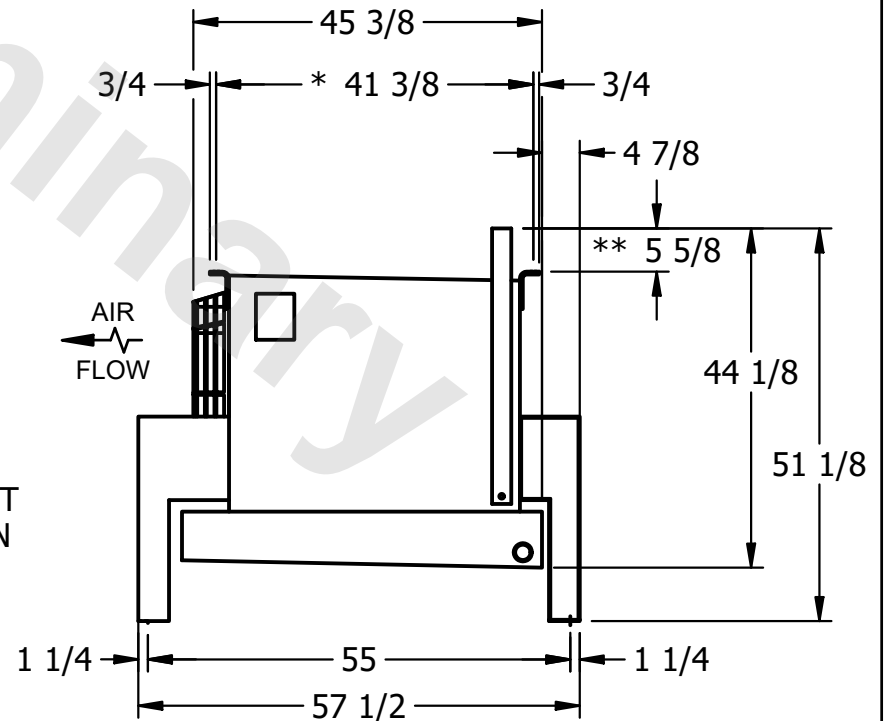
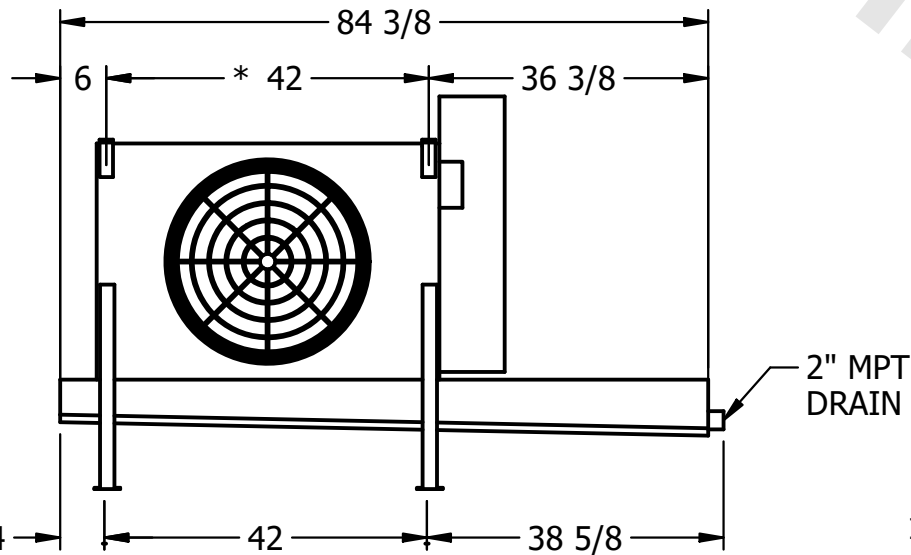

PROJECT	ROOM	SHIPPING WEIGHT 550 lbs+ [250] kg+	OPERATING WEIGHT 630 lbs+ [290] kg+
---------	------	------------------------------------	-------------------------------------