

CONFIDENTIAL

This document is the property of Evapco, Inc. It should not be copied or disclosed without prior written authorization.

CUSTOMER	MODEL # U-EJETME2-1643F0050C1KA	SCALE N.T.S.	DWG. # UEJETM2-SE-12,14	REV. 0	DATE 2/24/2026
----------	---------------------------------	--------------	-------------------------	--------	----------------



NEMA 4X JUNCTION BOX

NOTES:

- 1) * = HANGER HOLE LOCATION.
- 2) RIGHT HAND MODEL SHOWN.
- 3) HANGER HOLES ARE FOR 3/4 INCH THREADED ROD.
- 4) WATER DEFROST ADDS 1 3/4" INCHES TO HEIGHT OF STANDARD UNIT AND CHANGES DRAIN SIZE.
- 5) ALL DIMENSIONS ARE FOR REFERENCE AND SHOULD NOT BE USED FOR PREFABRICATION OF PIPING OR SUPPORTS.
- 6) **= HEIGHT OF SUCTION HEADER AND INSTALLED THERMOWELL FITTING ABOVE CABINET. CUSTOMER IS RESPONSIBLE TO ACCOUNT FOR ADDITIONAL HEIGHT NECESSARY FOR RTD AND ACCESS.

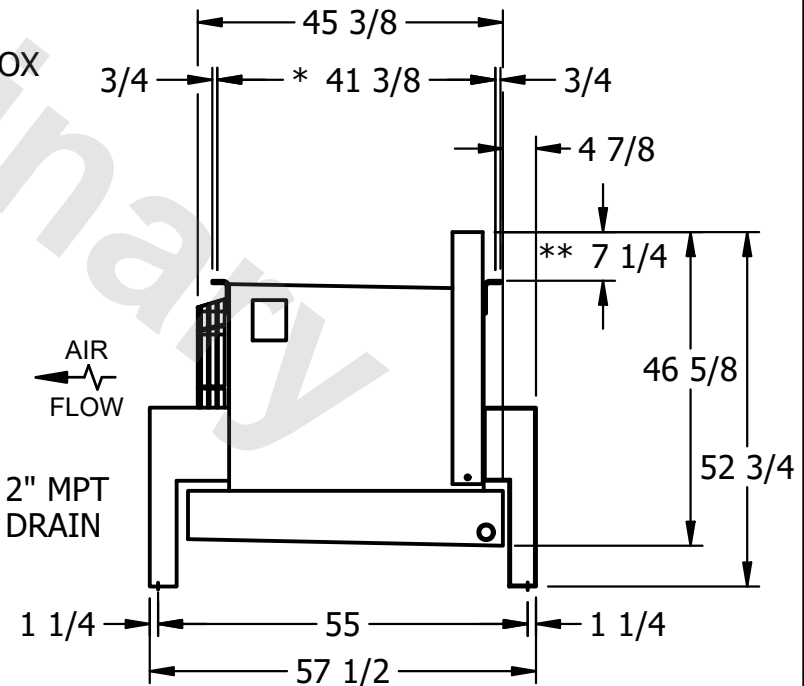
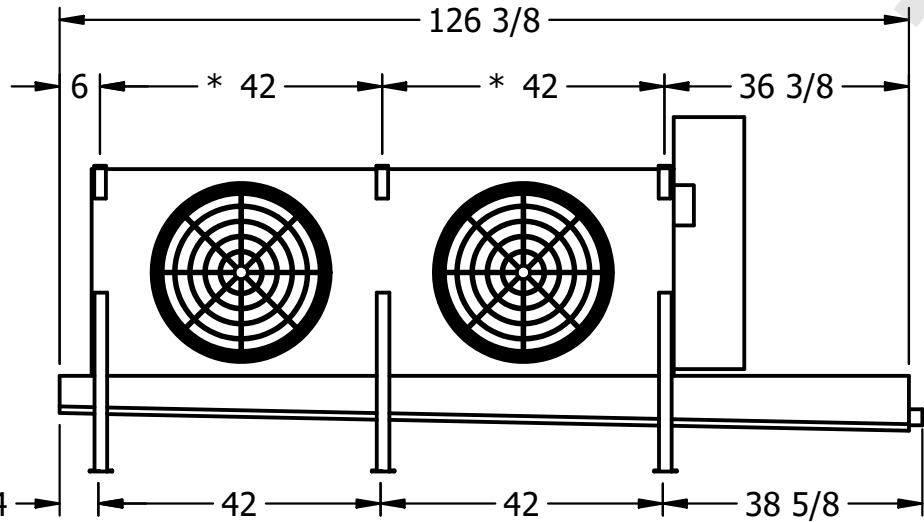

2" MPT DRAIN

PROJECT	ROOM	SHIPPING WEIGHT 840 lbs+ [385] kg+	OPERATING WEIGHT 910 lbs+ [415] kg+
---------	------	------------------------------------	-------------------------------------