

CONFIDENTIAL

This document is the property of Evapco, Inc. It should not be copied or disclosed without prior written authorization.

CUSTOMER	MODEL # U-EJETME2-1983H0100F1JA	SCALE N.T.S.	DWG. # UEJETM2-SE-16,18	REV. 0	DATE 4/23/2026
----------	---------------------------------	--------------	-------------------------	--------	----------------



NOTES:

- 1) * = HANGER HOLE LOCATION.
- 2) RIGHT HAND MODEL SHOWN.
- 3) HANGER HOLES ARE FOR 3/4 INCH THREADED ROD.
- 4) WATER DEFROST ADDS 1 3/4" INCHES TO HEIGHT OF STANDARD UNIT AND CHANGES DRAIN SIZE.
- 5) ALL DIMENSIONS ARE FOR REFERENCE AND SHOULD NOT BE USED FOR PREFABRICATION OF PIPING OR SUPPORTS.
- 6) **= HEIGHT OF SUCTION HEADER AND INSTALLED THERMOWELL FITTING ABOVE CABINET. CUSTOMER IS RESPONSIBLE TO ACCOUNT FOR ADDITIONAL HEIGHT NECESSARY FOR RTD AND ACCESS.



NEMA 4X JUNCTION BOX



5 3/4

6

42

42

42

42

42

42

42

42

42

42

42

42

42

42

42

42

42

42

42

42

42

42

42

42

42

42

42

42

42

42

42

42

42

42

42

42

42

42

42

42

42

2" MPT DRAIN

AIR FLOW

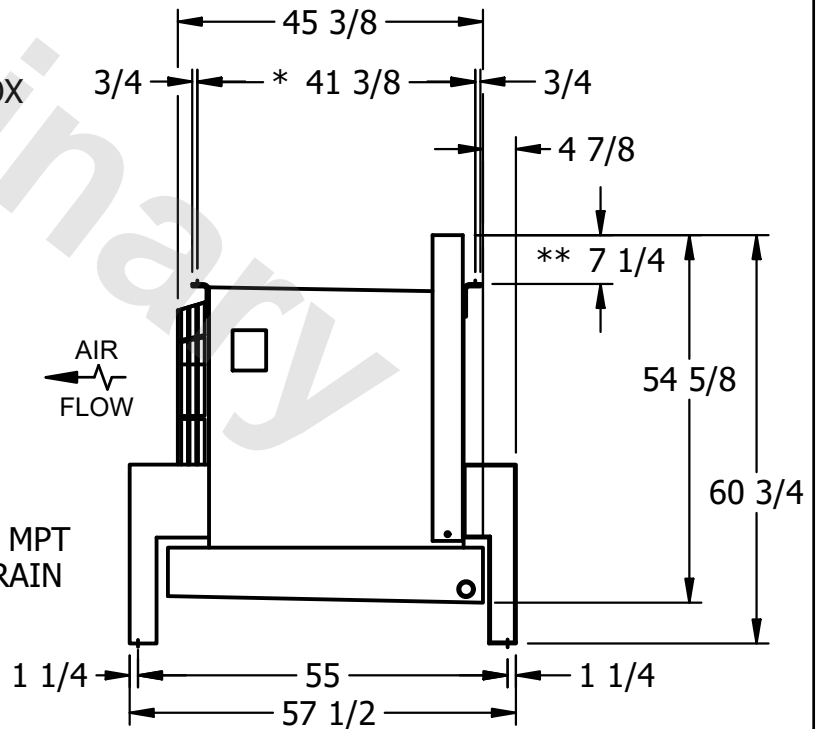

PROJECT	ROOM	SHIPPING WEIGHT 1170 lbs+ [535] kg+	OPERATING WEIGHT 1320 lbs+ [600] kg+
---------	------	-------------------------------------	--------------------------------------