

CONFIDENTIAL

This document is the property of Evapco, Inc. It should not be copied or disclosed without prior written authorization.

| | | | | | |
|----------|----------------------------------|--------------|-------------------------|--------|----------------|
| CUSTOMER | MODEL # U-EJETME2-16106H0050C1KA | SCALE N.T.S. | DWG. # UEJETM2-SE-12,14 | REV. 0 | DATE 4/19/2026 |
|----------|----------------------------------|--------------|-------------------------|--------|----------------|



NOTES:

- 1) * = HANGER HOLE LOCATION.
- 2) RIGHT HAND MODEL SHOWN.
- 3) HANGER HOLES ARE FOR 3/4 INCH THREADED ROD.
- 4) WATER DEFROST ADDS 1 3/4" INCHES TO HEIGHT OF STANDARD UNIT AND CHANGES DRAIN SIZE.
- 5) ALL DIMENSIONS ARE FOR REFERENCE AND SHOULD NOT BE USED FOR PREFABRICATION OF PIPING OR SUPPORTS.
- 6) **= HEIGHT OF SUCTION HEADER AND INSTALLED THERMOWELL FITTING ABOVE CABINET. CUSTOMER IS RESPONSIBLE TO ACCOUNT FOR ADDITIONAL HEIGHT NECESSARY FOR RTD AND ACCESS.

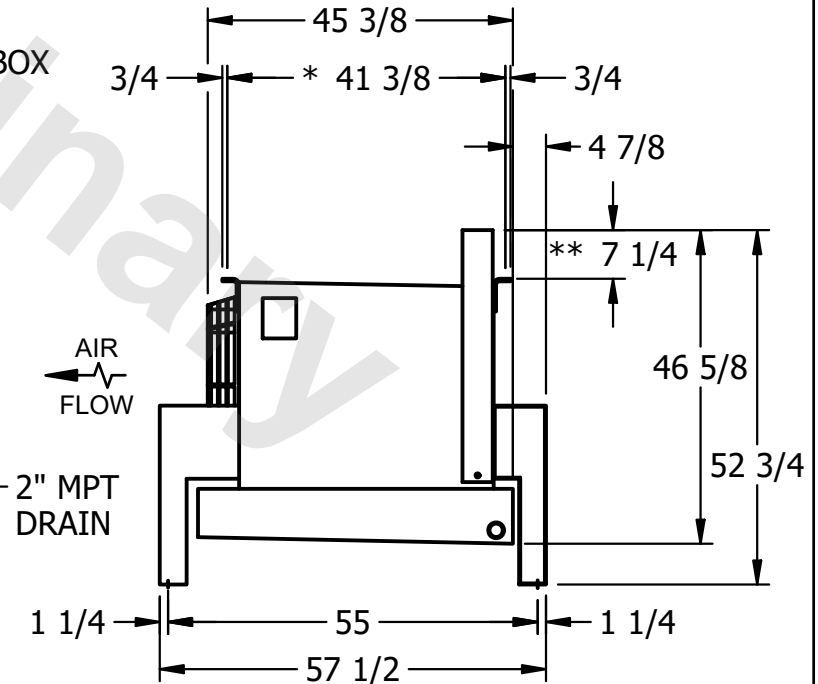

| | | | | | |
|---------|------|-----------------|---------------------|------------------|---------------------|
| PROJECT | ROOM | SHIPPING WEIGHT | 1540 lbs+ [700] kg+ | OPERATING WEIGHT | 1790 lbs+ [815] kg+ |
|---------|------|-----------------|---------------------|------------------|---------------------|