

**CONFIDENTIAL**

This document is the property of Evapco, Inc. It should not be copied or disclosed without prior written authorization.

**EVAPCO, INC.**



|          |                               |              |                      |        |                |
|----------|-------------------------------|--------------|----------------------|--------|----------------|
| CUSTOMER | MODEL # EJETXE2-1466F0050A1MA | SCALE N.T.S. | DWG. # EJETXE2-SE-12 | REV. 0 | DATE 4/19/2026 |
|----------|-------------------------------|--------------|----------------------|--------|----------------|

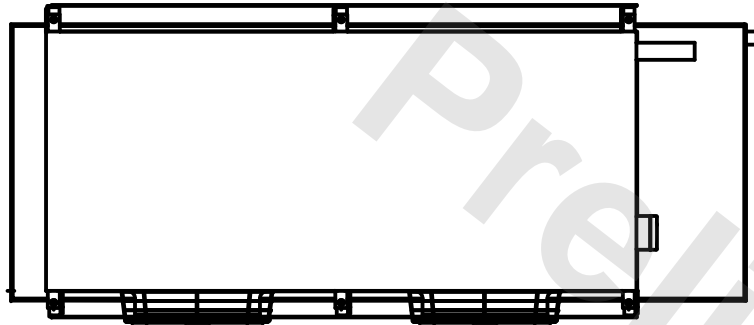

**NOTES:**

- 1) \* = HANGER HOLE LOCATION.
- 2) RIGHT HAND MODEL SHOWN.
- 3) HANGER HOLES ARE FOR 3/4 INCH THREADED ROD.
- 4) WATER DEFROST ADDS 6 1/2" INCHES TO HEIGHT AND 5" TO THE WIDTH OF THE STANDARD UNIT AND CHANGES DRAIN SIZE.
- 5) ALL DIMENSIONS ARE FOR REFERENCE AND SHOULD NOT BE USED FOR PREFABRICATION OF PIPING OR SUPPORTS.
- 6) \*\*= HEIGHT OF SUCTION HEADER AND INSTALLED THERMOWELL FITTING ABOVE CABINET. CUSTOMER IS RESPONSIBLE TO ACCOUNT FOR ADDITIONAL HEIGHT NECESSARY FOR RTD AND ACCESS.



|         |      |                         |                          |
|---------|------|-------------------------|--------------------------|
| PROJECT | ROOM | SHIPPING WEIGHT 840 lbs | OPERATING WEIGHT 970 lbs |
|---------|------|-------------------------|--------------------------|