

CONFIDENTIAL

This document is the property of Evapco, Inc. It should not be copied or disclosed without prior written authorization.

EVAPCO, INC.



CUSTOMER	MODEL # EJETHE4-11964E0200K2KA	SCALE N.T.S.	DWG. # EJETHE4-SE-32	REV. 0	DATE 6/2/2026
----------	--------------------------------	--------------	----------------------	--------	---------------

NOTES:

- 1) * = HANGER HOLE LOCATION.
- **= FOOT PLATE MOUNTING HOLE LOCATION
- 2) RIGHT HAND MODEL SHOWN.
- 3) HANGER HOLES ARE FOR 3/4 INCH THREADED ROD.
- 4) WATER DEFROST ADDS 6" INCHES TO HEIGHT OF STANDARD UNIT AND CHANGES DRAIN SIZE.
- 5) ALL DIMENSIONS ARE FOR REFERENCE AND SHOULD NOT BE USED FOR PREFABRICATION OF PIPING OR SUPPORTS.
- 6) ***= HEIGHT OF SUCTION HEADER AND INSTALLED THERMOWELL FITTING ABOVE CABINET. CUSTOMER IS RESPONSIBLE TO ACCOUNT FOR ADDITIONAL HEIGHT NECESSARY FOR RTD AND ACCESS.



NEMA 4X
JUNCTION
BOX

* 41 3/8

23 1/2

AIR
FLOW

3" MPT DRAIN

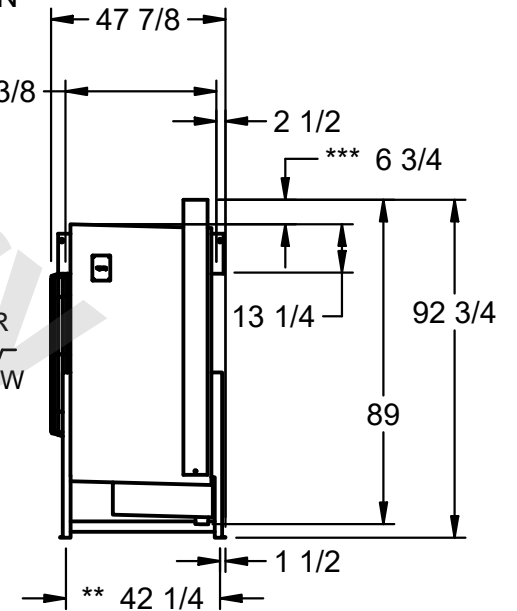

PROJECT	ROOM	SHIPPING WEIGHT 5190 lbs	OPERATING WEIGHT 6230 lbs
---------	------	--------------------------	---------------------------